

**SOPHOS**

Cybersecurity made simple.

# Operating Instructions

APX 320/530/740



### Foreword

We are pleased to welcome you as a new Sophos APX Series customer.

Sophos APX Series access points are high performance wireless products using the latest 802.11ac Wave 2 technology for a best-in-class user experience. The APX Series models can be easily managed in Sophos Central, our cloud-based security management platform. All you need to do is set up a Sophos Central account and plug in the device anywhere in your network. The access point will find the cloud-based controller automatically and become operable within seconds.

These operating instructions will help you setup your Sophos Central account, install and configure your Sophos APX Series access point and also provide detailed technical specifications. In addition, please also see the following documents that contain useful information on safety, regulatory compliance, and configuration options:

- Sophos APX Series Safety Instructions and Regulatory Information
- Sophos APX Series Quick Start Guide

The instructions must be read carefully prior to using the device and should be kept in a safe place. You can download all user manuals and additional documentation from the Sophos Knowledgebase under

[www.sophos.com/en-us/support/knowledgebase.aspx](http://www.sophos.com/en-us/support/knowledgebase.aspx) or from [www.sophos.com/get-started-ap](http://www.sophos.com/get-started-ap).



### Security Symbols

The following symbol and its meaning appears in the Quick Start Guide, Safety Instructions and in these Operating Instructions.

Caution and Important Note. If these notes are not correctly observed:

- This is dangerous to life and the environment
- The access point may be damaged
- The functions of the access point will be no longer guaranteed
- Sophos shall not be liable for damages arising from a failure to comply with the Safety Instructions

### Designed Use

The access point must be installed pursuant to the current installation notes. Otherwise failure-free and safe operation cannot be guaranteed. The EU declaration of conformity is available upon request from the following address:

**Sophos Technology GmbH**  
**Amalienbadstr. 41/Bau 52**  
**76227 Karlsruhe**  
**Germany**

## Operating Elements and Connections APX 320/530/740\*

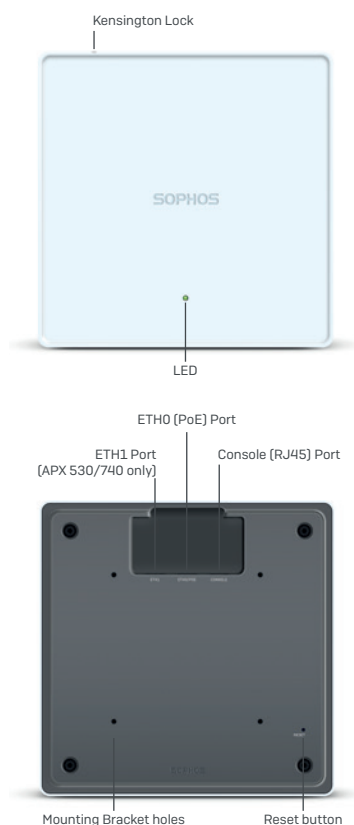

\* The displayed images show the APX 740. Other APX models may vary slightly.

### Component Descriptions

Component	Description
<b>Status LED</b>	The Status LED indicates the operational state of your access point such as boot status, firmware updates and error states. For details, see table "LED Status" below.
<b>Eth0 (PoE) and ETH1 ports</b>	Eth0 is the primary Ethernet port to connect your access point to your network. This port needs to be connected to a PoE capable source (PoE Injector or PoE switch) to power your access point. There is no dedicated DC power source available. Sophos offers suitable PoE injectors for purchase as an optional accessory.  Eth1 (on APX 530/740 only) can be used as an alternative Ethernet port but does not receive power.  Both Ethernet ports are 10/100/1000 Mbps compatible and auto-negotiate to the speed and half- and full-duplex of the connecting device.
<b>Console port</b>	For debugging purposes, support staff can access the CLI by making a serial connection to the RJ-45 console port.  For details, see "Serial Console Connection" below.
<b>Reset button</b>	The reset button allows you to reboot the device and reset its configuration to the factory default. For details, please see section "Reboot & Reset"
<b>Kensington Lock</b>	You can physically secure the AP by attaching a lock and cable (such as a Kensington® notebook lock) to the device lock slot.

## LED Status

LED on Front		
<b>Off</b>	Off	AP is off or reboot started
<b>Green</b>	Solid	Normal operation
	Flashing	AP is booting & connecting to wireless controller*
<b>Red</b>	Solid	Error, no wireless controller found. AP will reboot (if not yet claimed by a controller). Check network connection if error persists. If reset button pressed: AP preparing configuration reset
	Flashing slowly	Configuration reset in progress*
	Flashing fast	Firmware update in progress* <b>Note: Do not disconnect from power</b>

\* Your AP should recover from this state after a maximum of 5 minutes.

## Connection and Configuration

The initial connection of your access point to your network and the wireless controller is described in the APX Quick Start Guide which was shipped with your device or is available under [www.sophos.com/get-started-ap](http://www.sophos.com/get-started-ap).

For the access point to communicate with Sophos Central servers the following ports will need to be open on your firewall:

- 443 (HTTPS)
- 80 (HTTP)
- 123 (NTP)

After successful connection you can start your initial configuration.

## Setting up your access point in Sophos Central

You will need a Sophos Central account to manage your access points. Please go to <https://central.sophos.com> to sign in under your account or create a new account.

After signing in select *Wireless* from the popup screen or click on *Wireless* in the left navigation to get started.

Follow the Onboarding Wizard to register your access point.

For more information, please see the [Sophos Central Admin Help](#).

## Reboot & Reset

Your access point can be rebooted with the installed configuration or reset to the factory default configuration depending on how long you press and hold the reset button.

### Reboot with current image and configuration

1. Press reset button
2. Release reset button
3. AP reboots (LED will go off, then will turn to solid green)

### Reboot with current image and clear configuration

1. Press and hold reset button
2. AP reboots (LED will go off and then switch to green briefly)
3. LED will turn solid red for 5 sec. You can still cancel the configuration clearance process by releasing the reset button before the LED starts blinking
4. LED will blink red (configuration will be cleared)
5. Release reset button
6. AP reboots with factory default settings

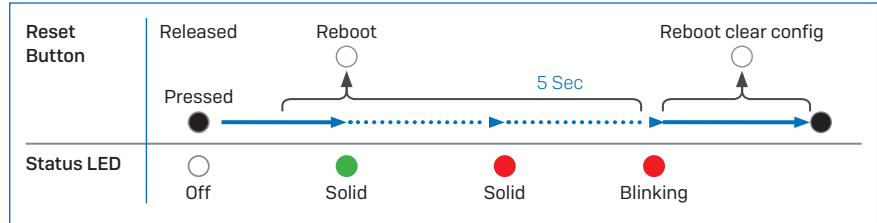

## Technical specifications

### APX 320

#### Environment

Power consumption	11.5 W (max.)
Power over Ethernet (PoE) requirements	802.3af
Operating temperature	0°-40° C
Storage temperature	-40°-70° C
Humidity	10-95% non-condensing
Hazardous substances	RoHS-2 and REACH compliant

#### Physical specification

I/O ports	1x RJ45 connector console serial port 1x RJ45 10/100/1000 Ethernet w/PoE (802.3af) 1x Reset button 1x Kensington security slot
Memory	512 MByte DDR3L 512 Mbyte NAND Flash 4 Mbyte SPI NOR Flash
Mounting	Desktop Wall-mount hang Ceiling (15/16, 9/16, 3/8 inch ceiling tracks)
Dimensions (Width x Depth x Height)	155x155x38 mm
Weight	0,474 kg

#### Wireless specification

Radios	1x 2.4 GHz/5 GHz dual-band 1x 5 GHz single band 1x Bluetooth low energy (BLE)
Antennas	2x internal dual band antenna for Radio-1 2x internal 5Ghz antenna for Radio-2 1x internal 2.4Ghz antenna for BLE
MIMO capabilities	2x2:2
Supported WLAN standards	IEEE 802.11 a/b/g/n/ac

Transmit Power		
<i>Mode</i>	<i>Bandwidth</i>	<i>Maximum EIRP [dBm]</i>
2.412-2.472 GHz (11b)	1-11 Mbps	23
2.412-2.472 GHz (11g)	6-9 Mbps	23
	12-18 Mbps	22
	24-36 Mbps	21
	48-54 Mbps	19
2.412-2.472 GHz (11n HT20)	MCS 0-1	23
	MCS 2-3	22
	MCS 4-5	21
	MCS 6-7	19
2.412-2.472 GHz (11n HT40)	MCS 7	19
5.180-5.825 GHz (11a)	6-9 Mbps	22
	12-18 Mbps	21
	24-36 Mbps	20
	48-54 Mbps	18
5.180-5.825 GHz (11ac VHT20)	MCS 0-1	22
	MCS 2-3	21
	MCS 4-5	20
	MCS 6-7	18
	MCS 8	17
5.180-5.825 GHz (11ac VHT40)	MCS8	17
	MCS9	17
5.180-5.825 GHz (11ac VHT80)	MCS8	15
	MCS9	14

## Radiation patterns

### 2.4 G Band

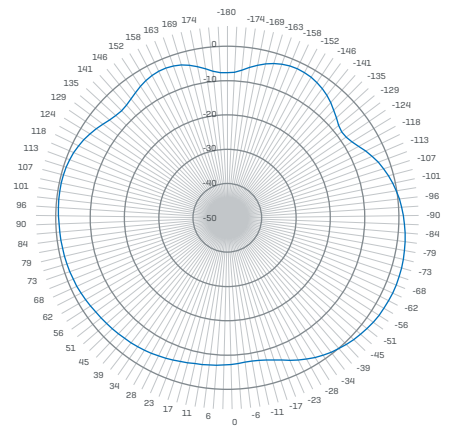
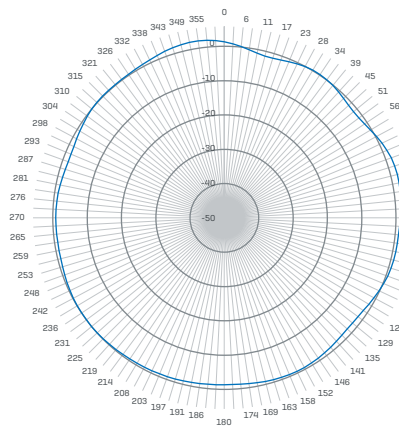

2.45 GHz Horizontal (XY)

2.45 GHz Elevation (YZ)

### 5 G Low Band

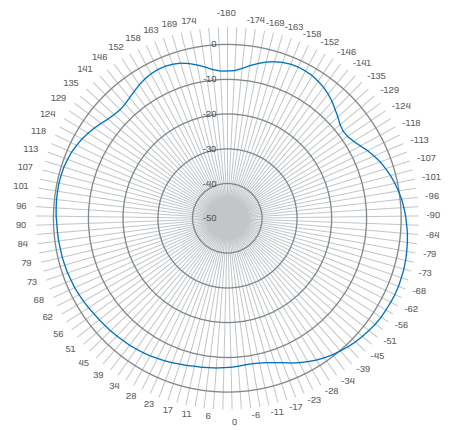
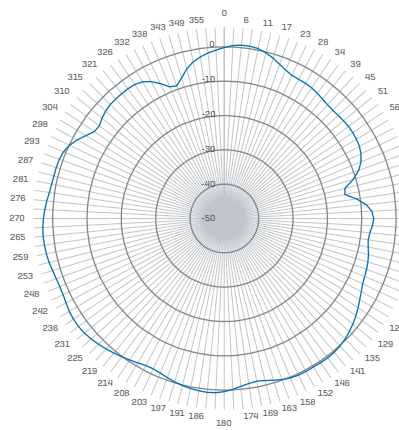

5.15 GHz Horizontal (XY)

5.15 GHz Elevation (YZ)

### 5 G High Band

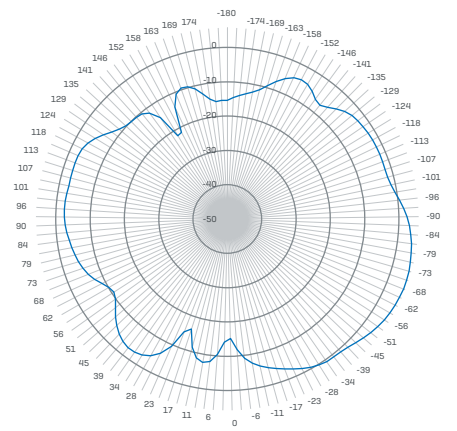
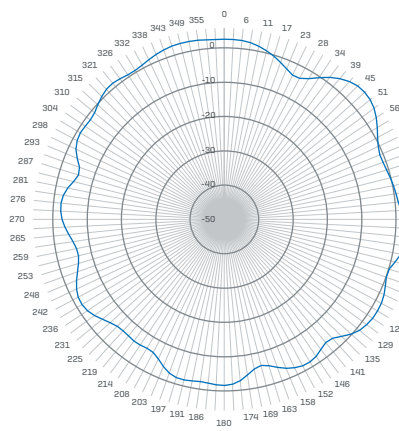

5.55 GHz Horizontal (XY)

5.55 GHz Elevation (YZ)

APX 530	
<i>Environment</i>	
Power consumption	16.7 W (max.)
Power over Ethernet (PoE) requirements	802.3at
Operating temperature	0°-40° C
Storage temperature	-40°-70° C
Humidity	10-95% non-condensing
Hazardous substances	RoHS-2 and REACH compliant
<i>Physical specification</i>	
I/O ports	1x RJ45 connector console serial port 1x RJ45 10/100/1000 Ethernet port 1x RJ45 10/100/1000 Ethernet w/PoE (802.3at) 1x Reset button 1x Kensington security slot
Memory	1 Gbyte DDR3L 512 Mbyte NAND Flash 4 Mbyte SPI NOR Flash
Mounting	Desktop Wall-mount hang Ceiling (15/16, 9/16, 3/8 inch ceiling tracks)
Dimensions (Width x Depth x Height)	183x183x39 mm
Weight	0,922 kg
<i>Wireless specification</i>	
Radios	1x 2.4 GHz single band 1x 5 GHz single band 1x Bluetooth low energy (BLE)
Antennas	3x internal 2.4 GHz antenna for Radio-1 3x internal 5 GHz antenna for Radio-2 1x internal 2.4 GHz antenna for BLE
MIMO capabilities	3x3:3
Supported WLAN standards	IEEE 802.11 a/b/g/n/ac

Transmit Power		
Mode	Bandwidth	Maximum EIRP (dBm)
2.412-2.472 GHz (11b)	1-11 Mbps	24
2.412-2.472 GHz (11g)	6-9 Mbps	23
	12-18 Mbps	23
	24-36 Mbps	22
	48-54 Mbps	20
2.412-2.472 GHz (11n HT20)	MCS 0-1	23
	MCS 2-3	22
	MCS 4-5	21
	MCS 6-7	19
2.412-2.472 GHz (11n HT40)	MCS 7	19
5.180-5.825 GHz (11a)	6-9 Mbps	21
	12-18 Mbps	20
	24-36 Mbps	19
	48-54 Mbps	18



Transmit Power		
5.180-5.825 GHz (11ac VHT20)	MCS 0-1	21
	MCS 2-3	20
	MCS 4-5	19
	MCS 6-7	18
	MCS 8	17
5.180-5.825 GHz (11ac VHT40)	MCS8	17
	MCS9	17
5.180-5.825 GHz (11ac VHT80)	MCS8	15
	MCS9	15

## Radiation patterns

### 2.4 G Band

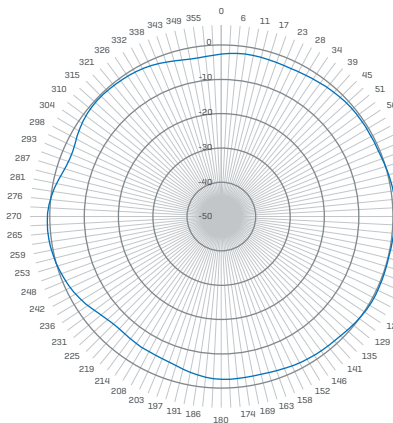

2.45 GHz Horizontal (XY)

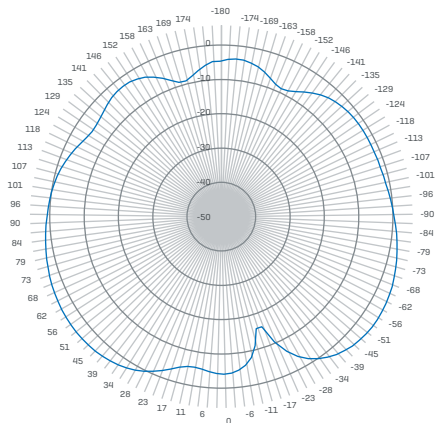

2.45 GHz Elevation (YZ)

### 5 G Band

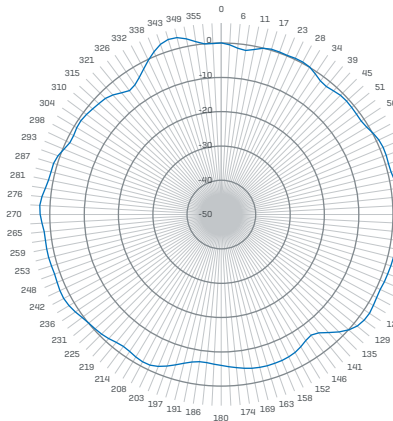

5.55 GHz Horizontal (XY)

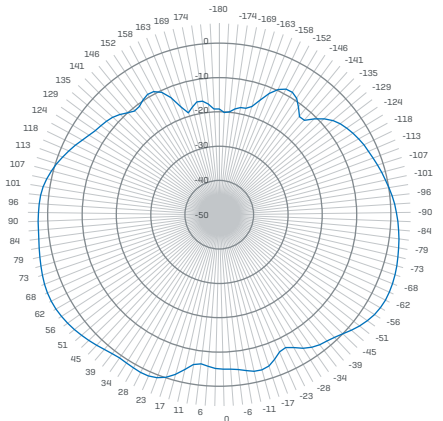

5.55 GHz Elevation (YZ)

## Technical specifications

APX 740	
<i>Environment</i>	
Power consumption	22.4 W
Power over Ethernet (PoE) requirements	802.3at
Operating temperature	0°-40° C
Storage temperature	-40°-70° C
Humidity	10-95% non-condensing
Hazardous substances	RoHS-2 and REACH compliant
<i>Physical specification</i>	
I/O ports	1x RJ45 connector console serial port 1x RJ45 10/100/1000 Ethernet port 1x RJ45 10/100/1000 Ethernet w/PoE (802.3at) 1x Reset button 1x Kensington security slot
Memory	1 Gbyte DDR3L 512 Mbyte NAND Flash 4 Mbyte SPI NOR Flash
Mounting	Desktop Wall-mount hang Ceiling (15/16, 9/16, 3/8 inch ceiling tracks)
Dimensions (Width x Depth x Height)	195x195x43 mm
Weight	1.012 kg
<i>Wireless specification</i>	
Radios	1x 2.4 GHz single band 1x 5 GHz single band 1x Bluetooth low energy (BLE)
Antennas	4x internal 2.4 GHz antenna for Radio-1 4x internal 5 GHz antenna for Radio-2 1x internal 2.4 GHz antenna for BLE
MIMO capabilities	4x4:4
Supported WLAN standards	IEEE 802.11 a/b/g/n/ac

Transmit Power		
Mode	Bandwidth	Maximum EIRP (dBm)
2.412-2.472 GHz (11b)	1-11 Mbps	24
2.412-2.472 GHz (11g)	6-9 Mbps	23
	12-18 Mbps	22
	24-36 Mbps	21
	48-54 Mbps	20
2.412-2.472 GHz (11n HT20)	MCS 0-1	23
	MCS 2-3	22
	MCS 4-5	21
	MCS 6-7	19
2.412-2.472 GHz (11n HT40)	MCS 7	19
5.180-5.825 GHz (11a)	6-9 Mbps	22
	12-18 Mbps	21
	24-36 Mbps	20
	48-54 Mbps	19

Transmit Power		
5.180-5.825 GHz (11ac VHT20)	MCS 0-1	22
	MCS 2-3	22
	MCS 4-5	20
	MCS 6-7	18
	MCS 8	17
5.180-5.825 GHz (11ac VHT40)	MCS8	17
	MCS9	17
5.180-5.825 GHz (11ac VHT80)	MCS8	15
	MCS9	15

## Radiation patterns

### 2.4 G Band

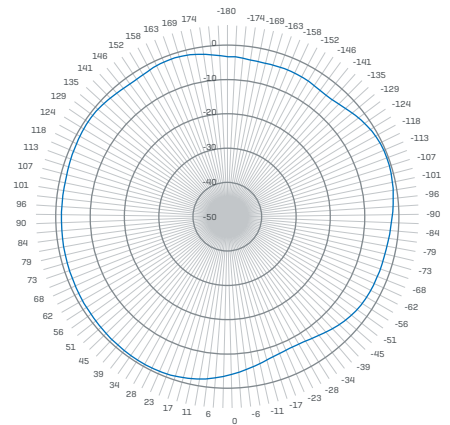
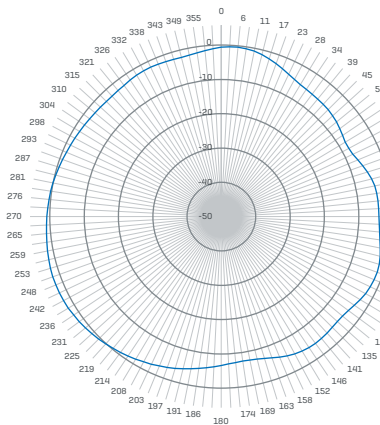

2.45 GHz Horizontal [XY]

2.45 GHz Elevation [YZ]

### 5G Band

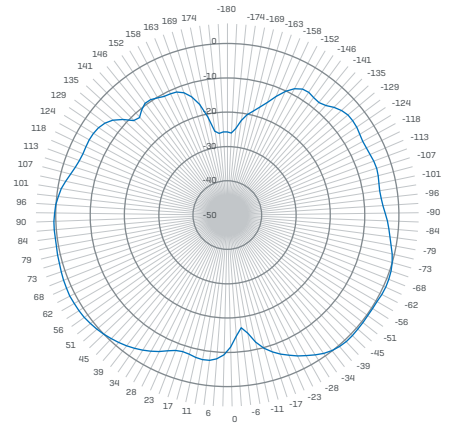
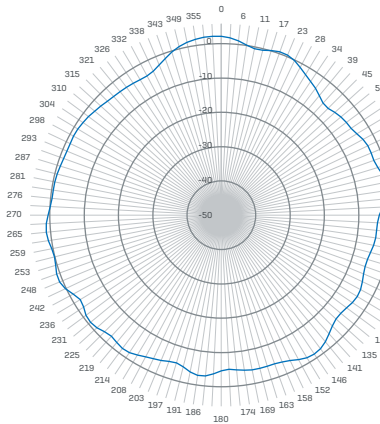

5.55 GHz Horizontal [XY]

5.55 GHz Elevation [YZ]

## Mounting instructions

There are various mounting options available allowing you to hang your access point on the wall or mount it to various ceiling types. The following sections provide detailed instructions for the various options which are available today.

Additional options, e.g. for flat ceiling mount, plenum mount, suspend mount, and Armstrong Silhouette and Interlude mount will be available through further optional mounting kits in the near future.

### Standard Wall and ceiling rails mount

Each Sophos Access Point APX 320, APX 530, and APX 740 ships with a mounting bracket that supports the following mounting options:

- Ceiling mount for 15/16", 3/8" and 9/16" ceiling track, flush ceiling tiles
- Wall mount hang

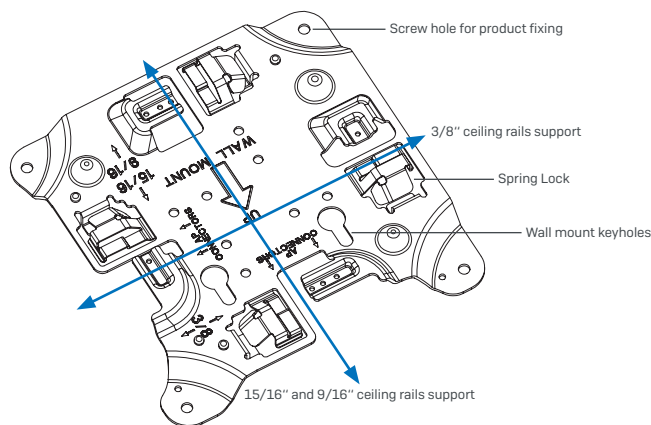

APX 320/530/740 Mounting template

Do not shrink to fit when printing

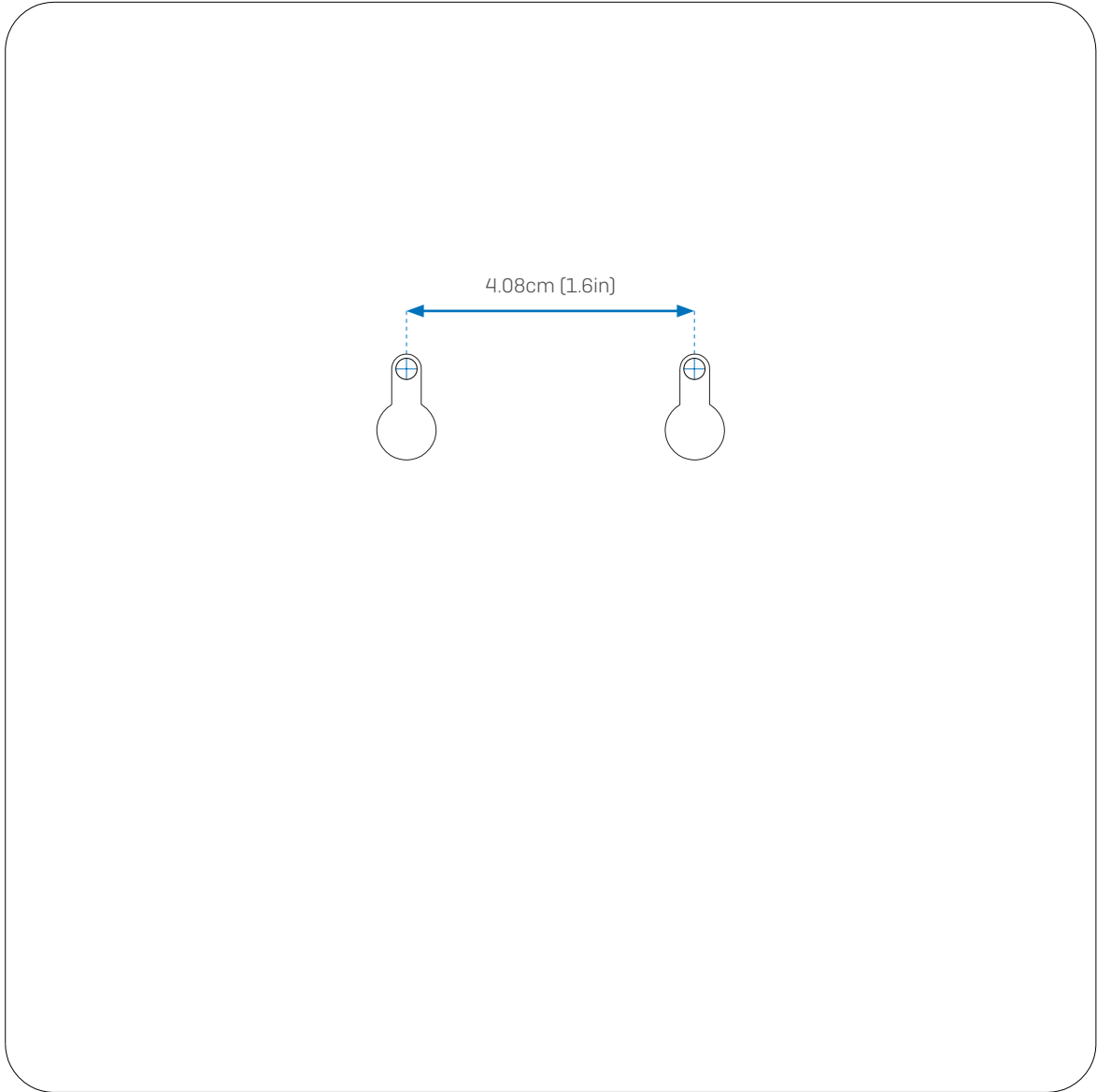

### Ceiling mount

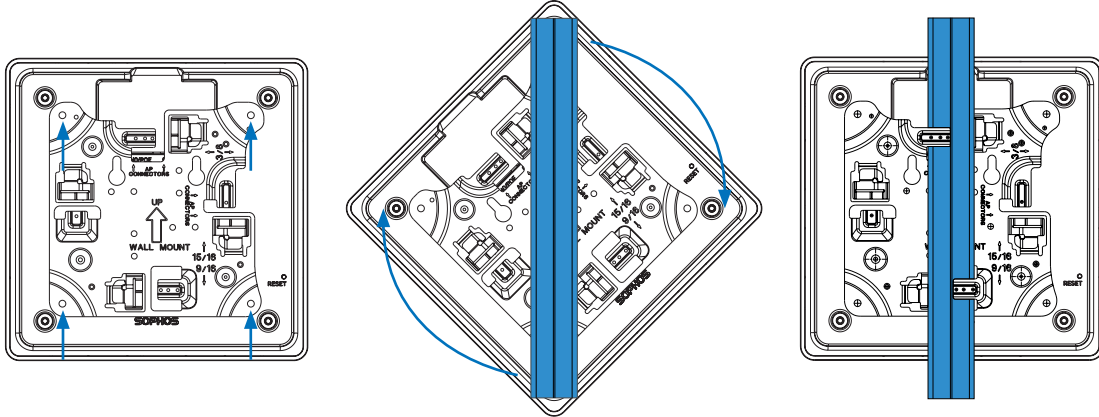

1. Fix the bracket to the rear of the Access Point by using 4 of the supplied screws.
2. To install, put the access point underneath the ceiling rail and turn it into place. To dismantle, push down the spring locks and turn the access point in the other direction.

### Wall mount

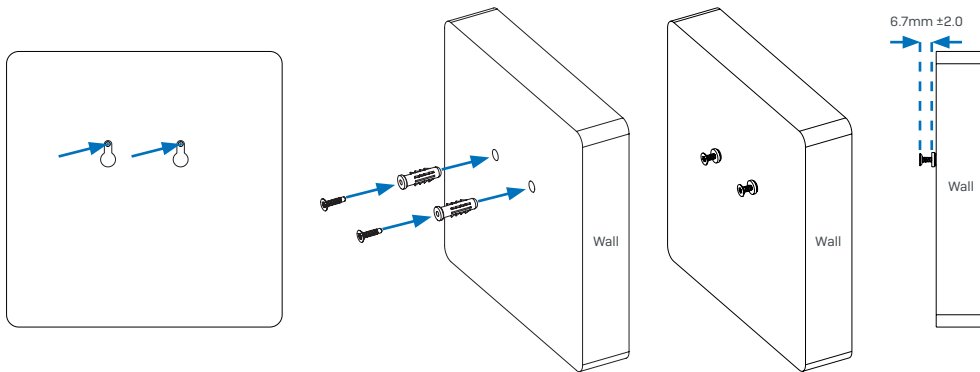

1. Use the mounting template to mark the screw mounting positions on the wall
2. Drill the 2 supplied wall anchors into the wall at the marked positions and screw 2 supplied screws into them. Make sure they stand out ~6.7mm

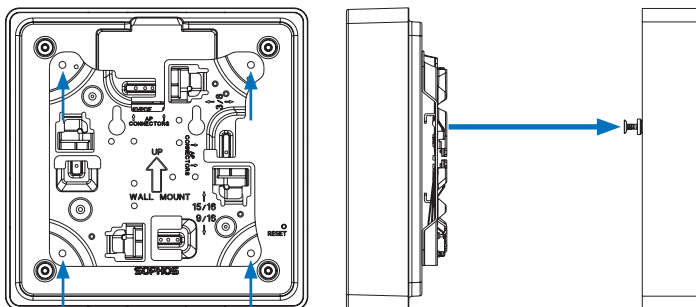

3. Fix the bracket to the rear of the Access Point by using 4 of the supplied screws.
4. Hang the access point (with the mounted bracket) to the wall by aligning the key holes with the mounted screws

### Flat ceiling mount

An optional flat ceiling mount kit will be made available soon.

### Plenum mount

An optional plenum mount kit will be made available soon.

### Suspend mount

An optional suspend mount kit will be made available soon.

### Armstrong interlude and silhouette mount

An optional mounting kit will be made available soon.

## Serial Console Connection

You can connect a serial console to the RJ45 COM port of your Access Point. For example, you can use the HyperTerminal program which is included with most versions of Microsoft Windows to log onto the appliance console. Use an appropriate adapter to connect the console to your hardware appliance.

The required connection settings are:

- › **Bits per second:** 38,400
- › **Data bits:** 8
- › **Parity:** N [none]
- › **Stop bits:** 1

Access via the serial console is activated by default on ttyS1.

United Kingdom and Worldwide Sales  
Tel: +44 (0)8447 671131  
Email: sales@sophos.com

North American Sales  
Toll Free: 1-866-866-2802  
Email: nasales@sophos.com

Australia and New Zealand Sales  
Tel: +61 2 9409 9100  
Email: sales@sophos.com.au

Asia Sales  
Tel: +65 62244168  
Email: salesasia@sophos.com