



P7

PoE-Touch Fingerprint and RFID Access Control

User Manual

(V1.0)



PREFACE

Honorable customers:

Thank you for choosing products from Anviz Technology Co.,Ltd. Our products contain world cutting edge technologies like Fingerprint/Iris/card Recognition and other biometric recognitions, Surveillance, Computer Communication, as well as Microelectronics. With the combination of three technologies: Electronics, Optics, and Computer Communication; Anviz Technology Co.,Ltd. is fast becoming the first choice for standalone time & attendance products for enterprises with its strong functions and veracity. Please read the user manual carefully before installation. You will have a general understanding of product functions and basic knowledge of installation, debugging, maintenance, application and management to better use this product.

Our product adopts the latest fingerprint and RFID recognition technology. It will bring enterprises the unparalleled reliability and convenience. In which users will get many benefits from using our products.

Software Operation Flowchart

This software includes: Attendance parameter, Department settings, Administrator management, Device management, Leave class, Holiday List and Attendance report etc. Then how to use this system in a right way? It is far from enough to understand only the function of each module but to know the connections between them and the system operation flowchart. Thus, a correct report can be generated. Software operation flowchart can be described in brief as follows:

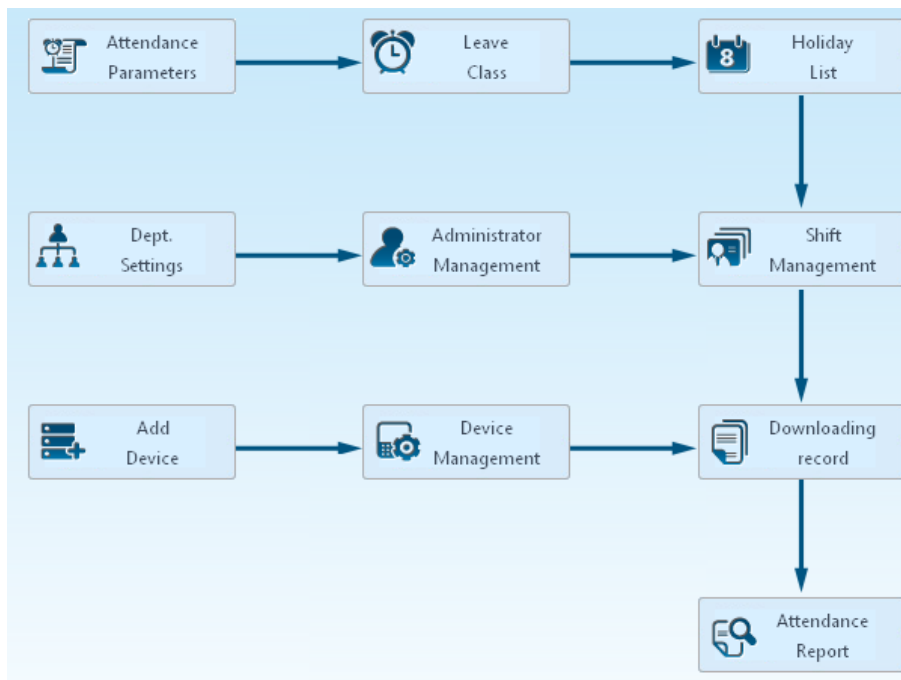

1. When the software is run for the first time, please set parameters including department name, time attendance rule, statistic rule for early, late and overtime, leave class etc. When the setting is completed, it is usually not needed to be modified unless the management rules of this company changes.
2. Normally there are many departments in one company and all departments need to be entered manually unlike the directly import of Employee. Department setting should be completed before Employee maintenance.
3. When the software is used for the first time, please make an MS Excel file (*.xls) for company



Employee in accordance with certain format. For the format, please refer to  so that all Employee can be imported to the system at one time. Employee can be added, deleted, modified and transferred to new department during future use.

4. First add the proper scheduling (from on-duty time to off-duty time) according to the company rule and then set shifts.

5. After the shift setting is completed, it will work until shift is allocated to Employee. Each Employee can only have one shift. Please note the starting date of the shift. After the allocation of the shift, the arranged working date and time can be seen clearly for each Employee.
6. Attendance records are stored in the time attendance unit. Please download the records from the unit before report calculation. In addition, staff information and fingerprint templates can be uploaded and downloaded between the unit and the computer.
7. There is always staff away for business, asking for leave and forgetting clock happening in a company. Once it occurs, please deal with it in time in the software to ensure the correctness of the statistic report.
8. After all the above mentioned operation is done, the calculation of report can be operated. The report can calculate the time attendance status of all Employees or a certain Employee from a certain department in a certain time period.

In [Attendance], first please select the begin and end date of the Employee, click 'Statistical Analysis' and the system will calculate automatically and check the validity of the records. (There are some invalid records during the use of the unit. For instance, if one Employee presses the finger twice during a very short time period, one of the records will be regarded as invalid.) If there is any error in the software calculation, admin can also modify manually to ensure the correctness of the result.

Note: From the above flowchart, we can see that if there is an error in calculation report for one staff, the possible reasons are as follows:

- Employee shift or temporary shift is incorrect.
- Exceptions such as Employee away for business/ask for leave/forgetting clock in/out is incorrect.
- Checking and calculation of transaction records is incorrect.

Contents

PREFACE.....	1
1 NOTICE FOR USER.....	7
1.1 Security Considerations	7
1.2 Illustration for Pressing Fingerprint	7
2 INTRODUCTION	9
2.1 Menu List	9
2.2 Features	9
2.3 Technical Parameters.....	10
3 OPERATION GUIDE	12
3.1 Keypad Instruction	12
3.2 Time Attendance Status.....	12
3.3 User.....	12
3.4 Setup.....	18
3.5 System Info	28
3.6 Shut Down	29
4 SOFTWARE INSTALLATION AND UNINSTALLATION.....	31
4.1 Operation Environment.....	31
4.2 System Installation.....	31
4.3 Uninstall software.....	33
5 COMMUNICATION	35
5.1 T&A Machine Management	35
5.2 Record Management	40
5.3 User Management.....	42
6 BACKGROUND MANAGEMENT	55
6.1 Log In System.....	55
6.2 System settings.....	57
6.3 Attendance Management.....	73
6.4 Data Management	76
6.5 Help.....	82
6.6 Software Upgrades	82
6.7 Feedback.....	83
6.8 About the Software.....	84
6.9 Help Documentation.....	84
7 FAQ.....	86
7.1 My fingerprint has been enrolled but often failed in identification.	86
7.2 T&A system can't be connected with PC.....	86
7.3 No records found even though staff have clocked in/out	86
7.4 The user cannot identify	86
7.5 Staffer can't pass although used the User ID+FP mode	87
7.6 The unit beeps automatically when no one punches in/out	87
7.7 Software connection failed.....	87

8	APPENDIX	89
8.1	<i>Communication And Power Interface</i>	89
8.2	<i>Access Wiring Diagram</i>	89

Chapter1 Notice For User

It's a comprehensive manual. Some specific functions are subject to actual device.

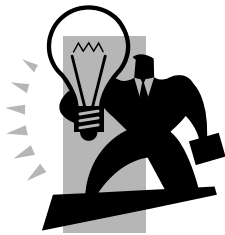

1 Notice For User

1.1 Security Considerations

Please read carefully before using the manual:

1. Please read it carefully first of all;
2. Don't install the terminal under direct light, humid, dusty or sooty environment;
3. Don't install the terminal near the magnetic field;
4. Don't install the terminal near the calefaction device;
5. Don't sprinkle the liquid (water, drink, chemistry) on the terminal;
6. Always keep the surface of the terminal clean;
7. Clear the terminal by towel when there is water on the surface;
8. Don't break the terminal;
9. Don't press two keys at the same time;
10. Don't take down, repair or change the terminal without authorization;
11. Don't allow children to touch the terminal;
12. This terminal is only used for fingerprint verification, don't use it for other purposes;
13. If in doubt, please contact the local distributor.

1.2 Illustration for Pressing Fingerprint

Correct method:



Place the center of the finger on the center of scanner window.

Wrong method:



Too less valid area Too left Too right Defluxion Too down

Note:

1. It is better for each user to register two finger prints in case of one finger can't work.
2. Place finger flat and make sure the center of the finger is on the center of scanner window and press a little hard on scanner so it can scan as large finger area as possible to extract enough minutia.
3. Keep the angle and direction of finger the same each time placing on scanner.
4. If your finger has sweat or water, please dry it first and then register the finger.
5. If your finger is too dry, make it a little wet or touch the forehead to increase the wetness of the finger, press a little hard on scanner. (The dry finger can cause the finger image not coming out clear enough.
6. Avoid the callus, peeling, or injury of the finger to ensure the register and identification successful.
7. You can register the thumb first, and then index finger or middle finger to increase the precision.

Chapter2 Introduction

The main theme of this chapter is the feature of this T&A product, as well as the function introduction.



2 Introduction

2.1 Menu List

Press [M] key to enter system management menu.

(This requires the administrator authorization if there is admin registered in the system.)

Menu List:

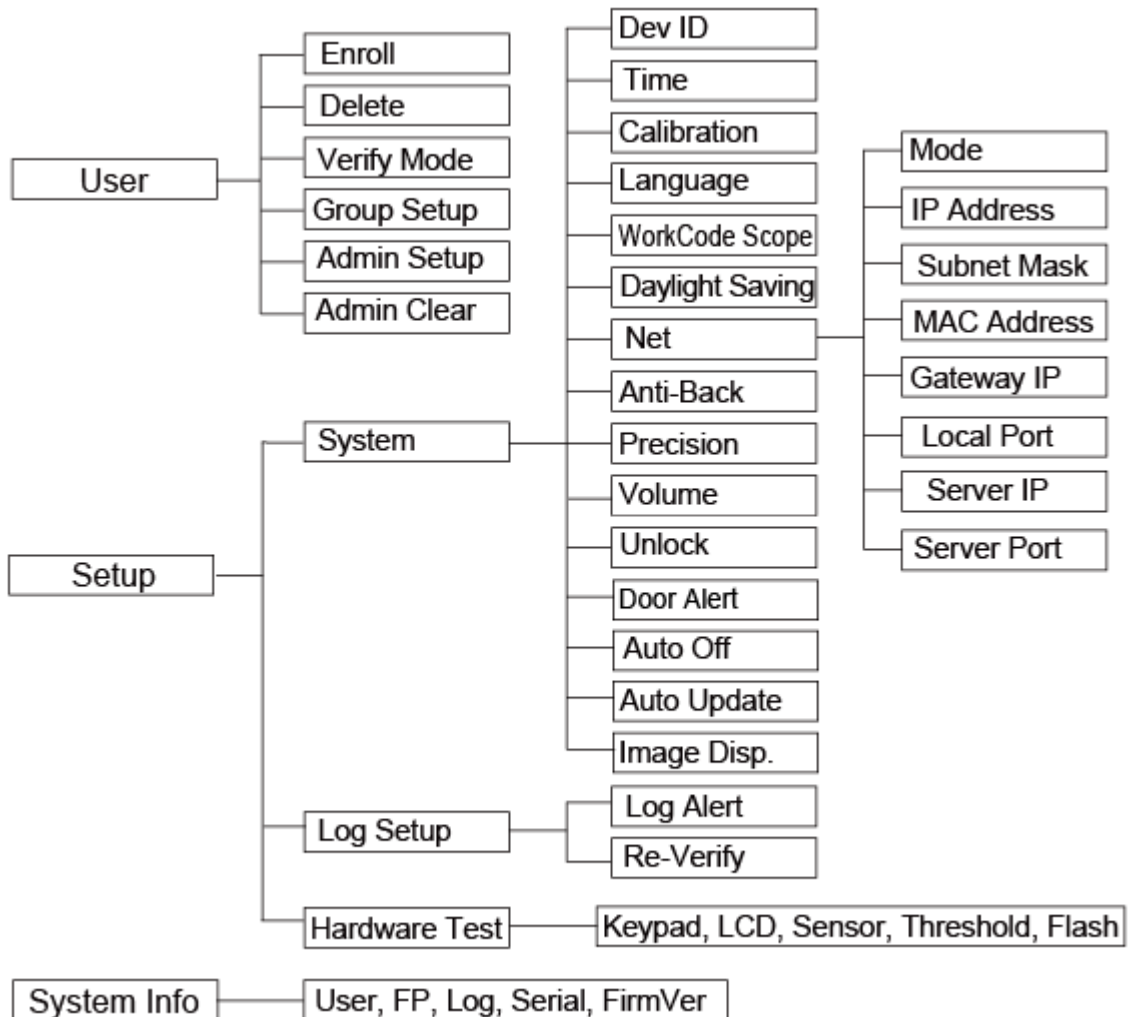

2.2 Features

- High Precision OLED Display
- Touch Keypad&Sensor
- Optical fingerprint scanner, wear-resistant, against spoiling long life
- Power Over Ethernet provide device network communication and the power is enough for both device and lock working
- Multi-identification: Fingerprint, Card, ID + fingerprint, ID + Password, Card + fingerprint and Card + Password

- Support Low-frequency card : EM Card and other compatible card(125kHz)
- Support TCP/IP, RS485, Mini USB Slave, Wiegand Out & In
- Can be connected with the SC011 access controller system to achieve split security
- Registration capacity: 3000 Fingerprints and 50000 Records

2.3 Technical Parameters

Item	Description
Comparison Time	<0.5 sec
Recognition Mode	Fingerprint, Password, Card
The area for the fingerprint collection	22mm*18mm
Image Resolution	500DPI
FRR	0.001%
FAR	0.00001%
Standard Interface	RS485, TCP/IP, Mini USB Slave, Wiegand Input and Output
Operating Voltage	DC12V
Relay	Relay Output (COM, NO, NC or Direct Lock Control)
POE	Nominal Power less than 13W
Operating Temperature/ Humidity	-25°C-70°C / 0%-90%
Material	ABS Engineering Plastics
Size	54(W)×170(H) ×41(D)mm
Color	Black

Chapter3 Operation Guide

This section explains terminal appearance, and operation. (Including how to add and remove users and how to set system parameters, etc.)



3 Operation Guide

3.1 Keypad Instruction

Keypad	Funciton	Keypad	Funciton
Fn	Work Code	C	Exit/Cancel Key
<	State Key(Clock In)/Up	0-9	Num. Keys
>	State Key(Clock Out)/Down	OK	Confirm Key/Power Key
M	Menu		

3.2 Time Attendance Status

Standby status we can run: time attendance, status setting, entering management mode and power off operation.

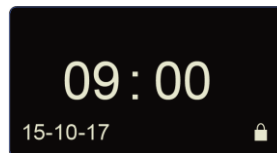

3.3 User

Employee info management includes user registration, user deletion; verify mode, group setting, manager setup and deletion.

Press [M] to enter system management mode. Select [User] option.

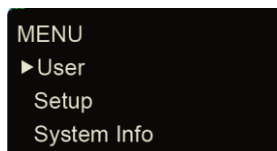

Press [OK] button to enter the sub-menu.

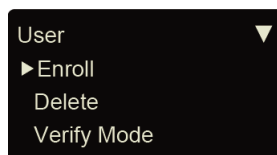

3.3.1 User Enroll

Select [Enroll] option and press [OK] to enter user registration interface. Input user ID, i.e. 8101.

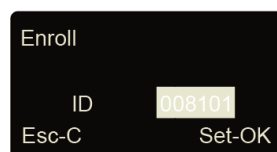

Press [OK] to continue.

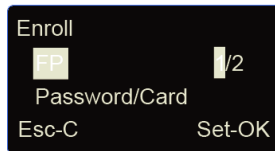

Fingerprint registration:

Press [<] or [>] key to select 1 or 2, 1 is to register the 1st FP, 2 is for 2nd FP.
Press [OK] to continue.



Place the finger on sensor scanner. Please follow the screen prompts to register the fingerprint.



Remove finger, the system will prompt.

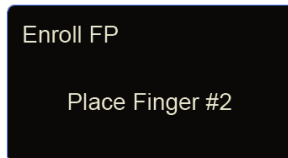

Place the same finger on sensor scanner again. After scanning successfully, the system will prompt as follow:



Press [OK] to save fingerprint. Press [C] back to user registration interface.
The 2nd finger registration as the same steps as above.

Password registration:

Press [<] or [>] key to [Password] option. Press [OK] to continue.

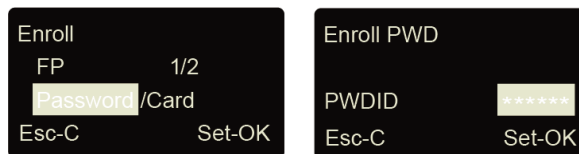

Please Input 1-6 digits as password. Press [OK] to confirm and input same password again. The system will prompt:



Press [OK] to save interface.

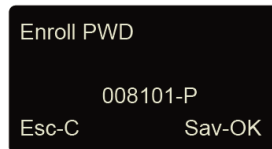

Press [OK] to save password. Press [C] to cancel and exit back to user registration interface.

Card registration:

Press [<] or [>] key to [Card] option. Press [OK] to continue.

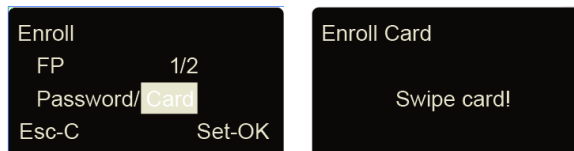

Swipe the ID card on card reader area. The terminal will get card number and enter save interface.

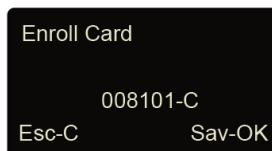

Press [OK] to save, press [C] to cancel and exit back to user registration interface.

3.3.2 User Deletion

When there are employees leaving, we need to delete these employees to free more memory space.

In [User] menu, press [<] or [>] to select [Delete] option.

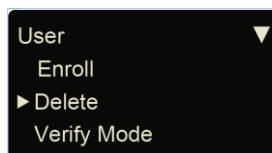

Press [OK] key to enter user deletion interface.

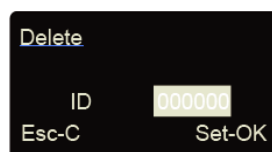

Input employee ID to delete. Press [OK] enter delete confirm interface.

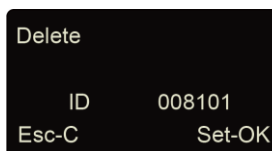

Press [OK] to confirm delete. Press [C] to cancel.

Note: Employee deletion will delete all information of the employee and can't be resumed. Please take caution!

When machine do not have this employee ID, the system will prompt as follow:

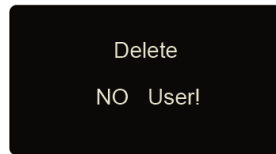

3.3.3 Verify Mode

Setting verify mode of the employee, there are four modes: SEPT, RF+PW, PW+FP, and RF+FP.

In [User] menu, press [<] or [>] key to select [Verify Mode] option:

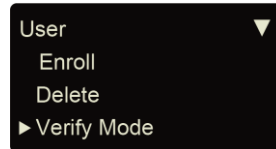

Press [OK] key to enter setting interface:

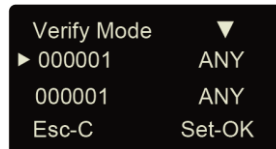

Press [<] or [>] key to select employee's ID or press [OK] to input user ID:

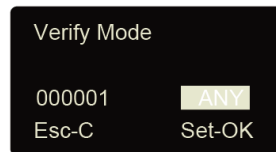

After input user ID, press [OK] to enter setting interface.

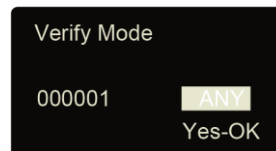

Setting employee's verify mode through [<] or [>] key, then press [OK] key to confirm and enter save interface:

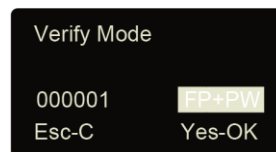

Then press [OK] key to save; Press [C] key to cancel this operation.

3.3.4 Group Setup

Group is based on time zones. One group can set max 4 time zone. There are supply 16 groups. Normally, system will default group 0 as normal close, group 1 as normal open.

In [User] menu, press [<] or [>] key to select [Group Setup] option.

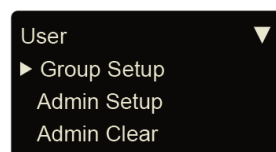

Press [OK] key to enter group setup interface.

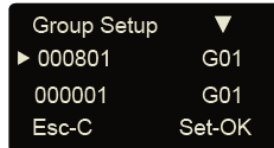

Press [<] or [>] key to select user ID or press [OK] to input user ID manually.

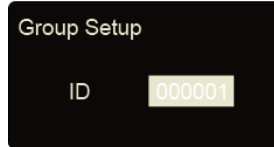

After input user ID, press [OK] to enter group interface.

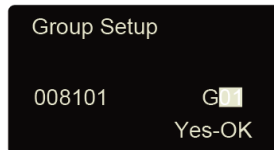

Group number can be input through [<] or [>] key or number key. (Max group number is 16). Press [OK] key to confirm and enter save interface.

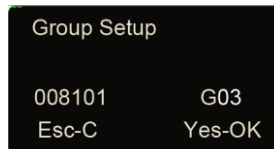

Then press [OK] key to save employee' group settings. Press [C] key to cancel this operation as well.

3.3.5 Admin Setup

To prevent illegal operation, we need to set device admin to enter menu. In [User] menu, press [<] or [>] key to select [Admin Setup] option:

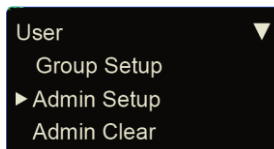

Press [OK] key to enter [Admin Setup] interface.

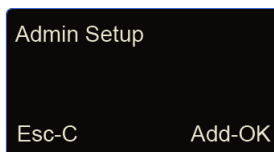

Press [OK] to start adding admin.

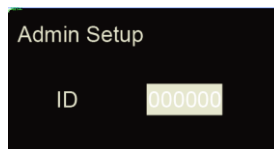

Input the user ID i.e. 8101. Press [OK] key to enter admin setup save interface.

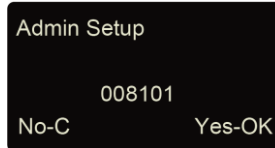

Press [OK] key again to confirm saving. After adding completed, exit to admin setup interface.

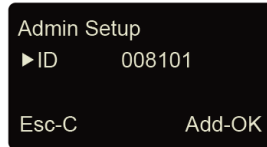

You can press [OK] key to continuously add other admin, and press [C] to exit as well. After adding admin, it needs the verification of the administrator's fingerprint to enter Menu. The interface is as following:

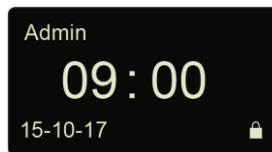

3.3.6 Admin Clear

Select [Admin Clear] option in [User] menu.

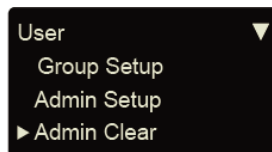

Press [OK] to enter admin clear interface.

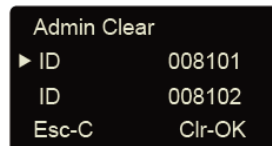

Press [<] or [>] key to choose the admin ID to be deleted, i.e. 8102:

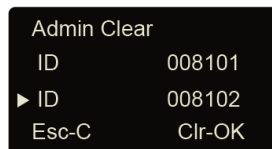

Press [OK] key to confirm the admin ID.

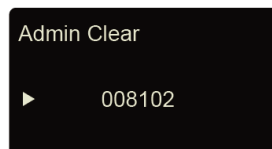

Note: in admin clear interface, you can press [OK] key to input admin ID and delete it manually. Press [OK] key again and confirm to delete manager 8102. Then exit to manager clear interface.

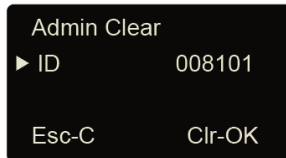

3.4 Setup

[Setup] menu mainly includes [System], [Log Setup] and [Hardware Test]. Enter management menu, press [<] or [>] key to select [Setup] option.

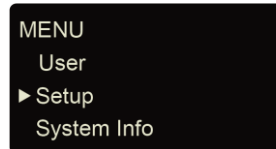

Press [OK] key to enter [Setup] sub-menu. Press [<] or [>] key to shift menu.

3.4.1 System Setup

3.4.1.1 Device ID

In [Setup] menu, press [<] or [>] key to enter [System] setup option.

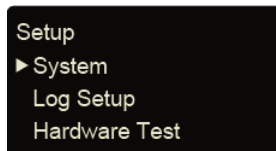

Press [OK] key to enter system setting sub-menu.

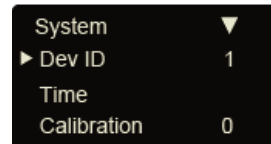

Note: Device ID range is 0-99999999, and default is 1.(Device ID must enter as same as in the communication software), When the device as -0 || , must use the lasted 8 digit of the serial number to communication with software.

3.4.1.2 Time

In [Setup] menu, press [<] or [>] key to enter [System] setup option.

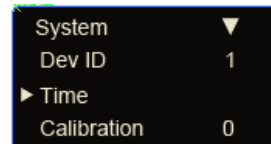

Press [OK] key to enter time setting interface.

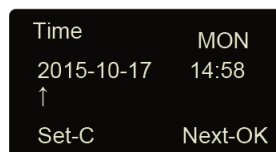

You can press the [OK] key to move the cursor to shift the year, month, day. And use number and [<] or [>] key adjust the time. After setting completed, press [C] key and enter system time save interface.

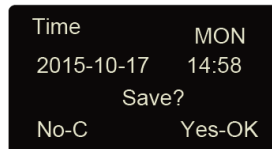

Press [OK] key to save system time. Press [C] key to cancel and exit to upper menu.

3.4.1.3 Calibration

In [System], press [<] or [>] key to select [Calibration] option.

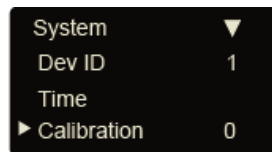

Press [OK] key to enter the time setting (Time unit: second).

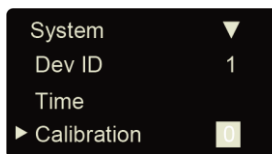

You can press [<] or [>] key to get the calibration time you need. And press [OK] to confirm. Then you can continue to do other function settings.

3.4.1.4 Language

In [System], press [<] or [>] key to select [Language] option.

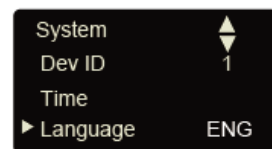

Press [OK] key to enter language setting interface.

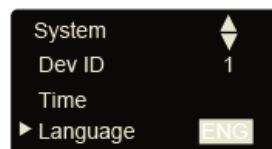

You can press [<] or [>] key to switchover the language. And press [OK] to confirm. Then you can continue to do other function settings. And press [C] key to enter setting save interface.

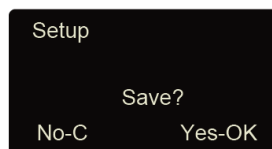

Press [OK] key to save system setting. Press [C] to cancel and exit to upper menu.

3.4.1.5 WorkCode Scope

Work code is a code for different work. Use for device supply a parameter to label an attendance record as which kind of the work. It is easy for count attendance time for different work. The scope of the work code is: 0-999999. It is an invalid when over this scope.

In [System], press [<] or [>] key to select [Work code scope] option.

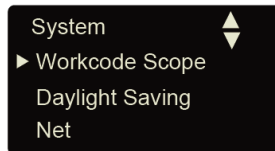

Press [OK] key to enter work code scope interface.

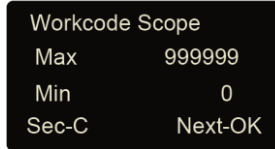

When you finish setting, press [C] key enter save interface.

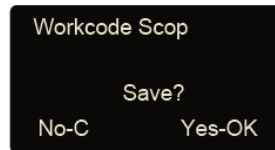

Press [OK] to confirm and save.

3.4.1.6 Daylight Saving

Automatically switch daylight saving time base on week or date.

In [System], press [<] or [>] key to select [Daylight Saving] option.

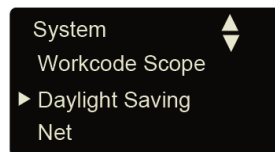

Press [OK] key to enter Daylight Saving interface:

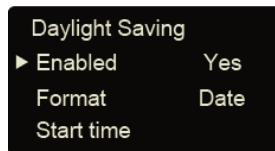

When you enable 'Daylight Saving' function you need select week or date format first. Then you need set the time point for 'Daylight Saving' start time and end time. And press [C] key enter save interface.

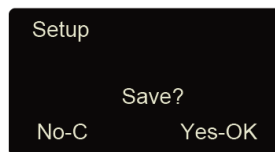

Press [OK] to Confirm and save.

3.4.1.7 Net

Network setting main includes [IP Address], [Subnet Mask], [MAC Address] and [Gateway IP] settings.

In [System], press [<] or [>] key to select [Net] option.

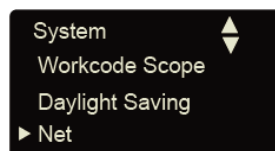

Press [OK] key to enter net parameter interface.

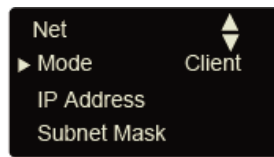

Mode:

There are two modes for networking.

Press [<] or [>] key to select [Server] or [Client].

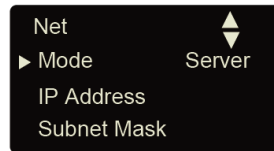

Server: Normal net mode;

Client: Only communication with the PC which has server IP.

IP Address

Press [<] or [>] key to select [IP address] option:

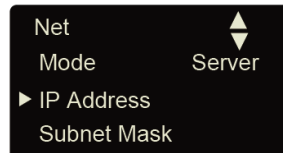

Press [OK] key to enter IP address setting interface:

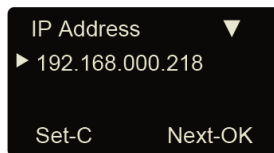

Press [<] or [>] key or number key to input IP address. Press [OK] key to shift between the 4 segments. After set is completed, press [C] key to enter IP address save interface.

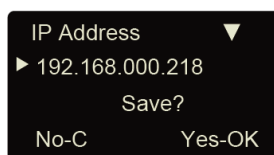

Press [OK] key to save the modification. Press [C] key to cancel.

Subnet Mask

Press [<] or [>] key to select [Subnet mask] option.

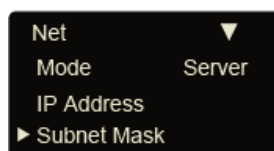

Press [OK] key to enter subnet mask setting interface.

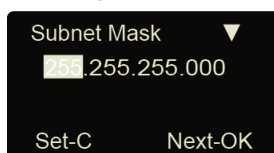

Press [<] or [>] key or number key to input subnet mask. Press [OK] key to shift between the 4 segments. After set is completed, press [C] key to enter subnet mask save interface.

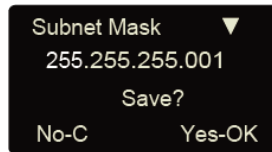

Press [OK] key to save the modification. Press [C] key to cancel.

MAC Address

Press [<] or [>] key to select [MAC Address] option.

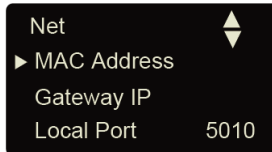

Press [OK] key to enter MAC address setting interface.

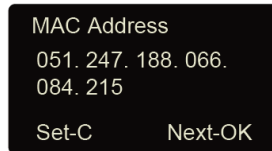

Please do not change the MAC address for device.

Press [OK] key to save the modification. Press [C] key to cancel.

Gateway IP

Press [<] or [>] key to select [Gateway IP] option.

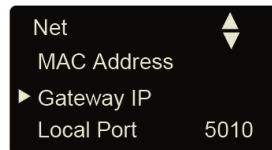

Press [OK] key to enter gateway IP setting interface.

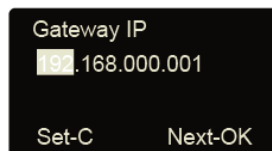

Press [<] or [>] key or number key to input gateway IP. Press [OK] key to shift between the 4 segments. After set is completed, press [C] key to enter gateway IP save interface.

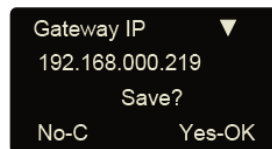

Press [OK] key to save the modification. Press [C] key to cancel.

Local Port:

Press [<] or [>] to select [Local Port] option:



Press [\leftarrow] or [\rightarrow] key or number key to input port. After set is completed, press [C] key to enter save interface.

Server IP address

Press [\leftarrow] or [\rightarrow] to select[Server IP]option:

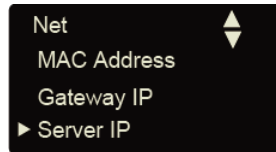

Press [OK] key to enter Server IP setting interface.

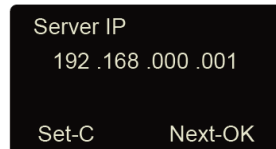

Press [\leftarrow] or [\rightarrow] key or number key to input server IP. After set is completed, press [C] key to enter save interface.

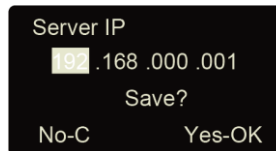

Press [OK] key to save the modification. Press [C] key to cancel.

Server port

Press [\leftarrow] or [\rightarrow] to select [Server port] option:

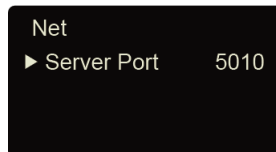

Press [\leftarrow] or [\rightarrow] key or number key to input server port. After set is completed, press [C] key to enter save interface.

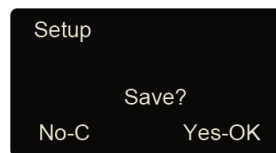

Press [OK] key to save the modification. Press [C] key to cancel.

3.4.1.8 Anti-Back

The anti-back feature is designed to prevent misuse of the access control system. The anti-back feature is most commonly used at parking gates and employee entrance doors, where there is both an 'in' reader at the entry gate and an 'out' reader at the exit gate. The anti-back feature requires that for every use of a card at the 'in' reader, there be a corresponding use at the 'out' reader before the card can be used at the 'in' reader again. P7 must work with T5s to realize anti-back function.

Via [\leftarrow] or [\rightarrow] select [Anti-Back] option:

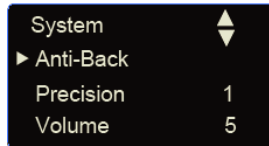

Press [OK] to confirm enter 'Anti Pass Back' menu.

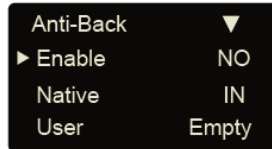

Enable: Enable or Disable anti-back function.

Native: Setting device always as 'In' or 'Out' states.

Empty User: Clear all the stranded user records which have been accessed in.

Press [<] or [>] key to setting the anti-back function and press[OK]to confirm, then press[C]save and exit.

3.4.1.9 Precision

There are three fingerprint matching precision levels (0, 1, and 2). 0 is lower precision (Basic) .1 is standard precision (Good). 2 is high precision (Excellent).

Press [<] or [>] key to select [Precision] option.

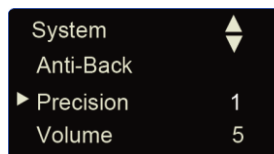

Press [OK] key to enter precision setting interface.

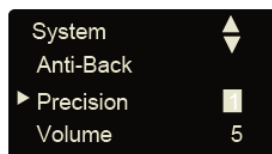

Press [<] or [>] key or number key to adjust the precision. Press [OK] key to confirm. Then press [C] to save the setting.

3.4.1.10 Volume

There are five levels for device's volume,0-mute,MAX-5.

In [System] setup, press [<] or [>] key to select [volume] option.

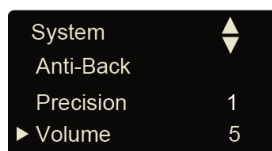

Press [OK] key to enter volume setting interface, Press [<] or [>] key set the volume. Press [OK] key to confirm. Then press [C] to save the setting.

3.4.1.11 Unlock

Lock delay is the time range since lock open to close after user access granted. 'No' means no delay and the max delay time is 15 seconds.

Press [<] or [>] key to select [Unlock] option.

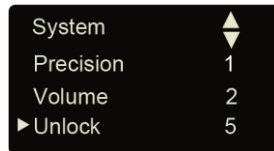

Press [OK] key to enter delay time setting interface.

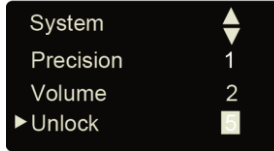

Press [<] or [>] key or number key to input delay time. Press [OK] key to confirm. Then press [C] to save the setting.

3.4.1.12 Door Alert

Door alert use for monitor lock whether door was closed after user access. If lock does not close the device will alarm out. The delay time for door alert is 1-99 sec and 'No' means disable the door alert function.

Press [<] or [>] key to select [Door Alert] option.

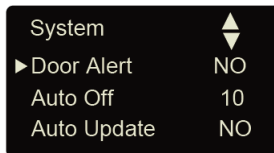

Press [OK] key to enter door alert setting interface.

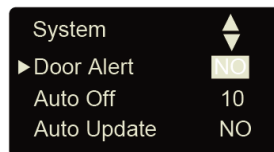

Press [<] or [>] key or number key to input door alert value. Press [OK] key to confirm. Then press [C] to save the setting.

3.4.1.13 Auto Off

Auto off is the time period from the last operation on device to coming into dormancy status. Time range is 1-250 minutes. 'No' is no dormancy forever.

Press [<] or [>] key to select [Auto off] option.

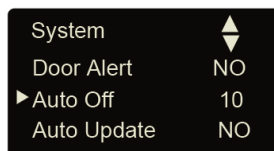

Press [OK] key to enter auto off setting interface.

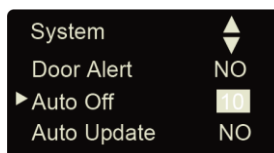

Press [<] or [>] key or number key to input dormancy time. Press [OK] key to confirm. Then press [C] to save the setting.

3.4.1.14 Auto Update

Update the fingerprint template intelligently: During fingerprint sensor identification process, the sensor replaces the lowest-quality data with new, higher-quality data that it acquired in the matching process. This enables the sensor to maintain high quality data at all times, saving the user from repeated authentication attempts.

Press [<] or [>] key and shift to [Auto Update] option:

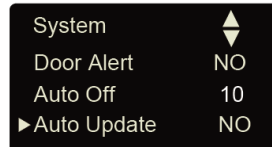

Press [OK] key to enter auto off setting interface:

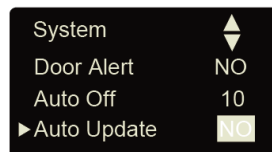

Press [<] or [>] key to choose 'Yes' or 'No', and then press [OK] key to confirm. Then press [C] to save the setting.

3.4.1.15 Image Disp.

Whether display the fingerprint image on the LCD after user access granted. In [System] setup, press [<] or [>] key to select [Image Disp.] option.

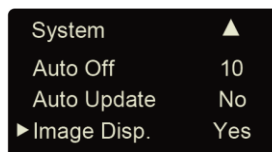

Press [OK] key to enter setting interface:

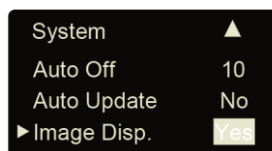

Press [<] or [>] key to choose 'Yes' or 'No', and then press [OK] key to confirm. Then press [C] to save the setting.

3.4.2 Log Setup

Log warning number has the highest limit of 5000. When the available records memory is less than the 'Glog Wrn', system will prompt corresponding operation.

Press [<] or [>] key to select [Log Setup] option.

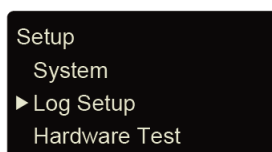

Press [OK] key to enter sub-menu.

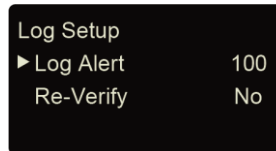

Press [<] or [>] key to select [Log Alert] option. Press [OK] key to enter log alert setting interface.

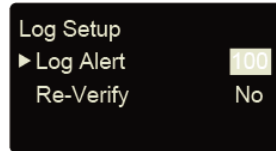

Press [<] or [>] key or number key to input log warning number. Press [OK] key to confirm. Then press [C] to save the setting.

3.4.3 Re-Verify Time

The Re-verify time is the time interval in which you make continuous records with the same finger (1-250 minutes), and then the device will only save the first record. If the re-verify value is 'NO', it means that you every record saved in the device.

In [Log Setup] menu, press [<] or [>] key to select [Re-Verify] option.

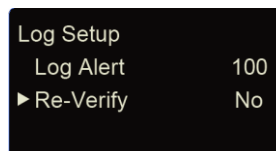

Press [OK] key to enter re-verify setting interface.

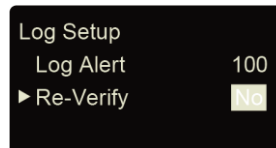

Press [<] or [>] key or number keypad to input time. Press [OK] key to confirm. Then press [C] to save the setting.

Prompt: If the same finger is identified continuously in re-verify time period, only the first record will be saved in device memory.

3.4.4 Hardware Test

Test the functions of machine keys, LCD, voice, scanner and Flash.

Select [Hardware test] option in [Setup] menu:

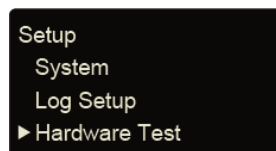

Press [OK] to enter setting interface as following:

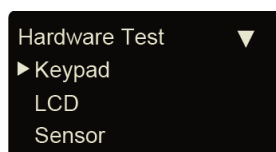

Press [<] or [>] key to choose testing option and press [OK] key to start. Keypad: press [<] or [>]

key to select [Keyboard] option, and press [OK] to enter keyboard testing interface. Then press any key to start keys testing (i.e. press key 3, if interface shows current key as 3, it indicates the key 3 works.)

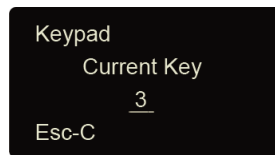

Press 'C' exit the test

LCD: Press [<] or [>] key to select [LCD] option, and press [OK] to enter LCD testing interface.



Press 'C' exit the test

Sensor: Press [<] or [>] key to select [Sensor] option, and press [OK] to enter sensor testing interface.

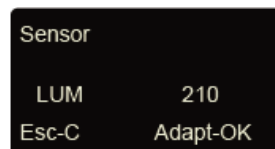

Press 'C' exit the test

Flash: Press [<] or [>] key to select [Flash] option, and press [OK] to enter flash testing interface.

Two steps: 1. Erase all data; 2. Check

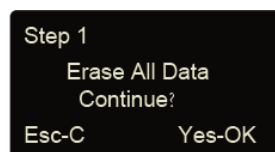

After checking completed, the interface will show the checking result.

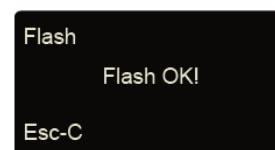

After each test are finished, press [C] key to exit.

3.5 System Info

System info shows the current usage status of device, such as user quantity, fingerprint quantity, records quantity and the firmware version etc.

In management mode, press [<] or [>] key and shift to [System Info] option,

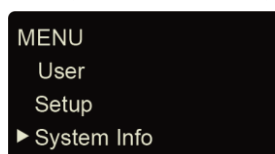

Press [OK] key to enter system info interface, and check info of correct operated device.

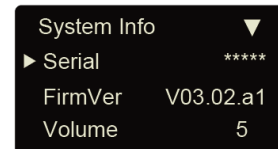
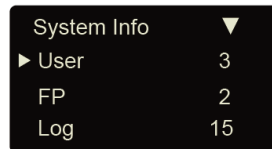

User: Registered user number in device.

FP: registered fingerprints number. Select it and press [OK] key and you can check the password and card number.

Log: The number of the attendance record stored in the device.

Serial: The unique identifier of the device and cannot be modified.

FirmVer: the firmware version of program which write in EROM or EPROM (Programmable read only memory). So called firmware is firm program saved in integrated circuit firmly, responsible for controlling and dealing with integrated circuit.

After checking completed, click [C] to exit.

3.6 Shut Down

In time attendance status, keep pressing [OK] key until interface shows as following.

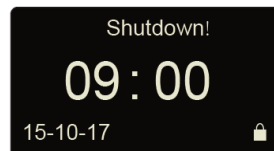

Then device will shut down.

Notice: If external power is connected, you can press [OK] key to power on device.

Chapter4 T&A software Installation and uninstallation

This chapter discusses the installation and un-installation of T&A software as well as the hardware and operation system requirement.



4 Software Installation and Uninstallation

First we should install background management software on the computer. Please refer to the following steps:

4.1 Operation Environment

Hardware requirement:

Pentium IV 1.5GHz above

1G Memory and above, Minimum 1GB hardware space

COM (USB Port)

CD-ROM (CD-ROM needed in installation)

VGA support 1024*768 resolution and above

Operation system: Microsoft Windows 2000(recommended)/Microsoft Windows XP/Win7

Database: MS Sql Server2000/Access

4.2 System Installation

Please insert the CrossChex CD into the computer CD-ROM drive. If you turn on the computer automatically run a CD, the installation program will run automatically. Otherwise, open the CD and run their own "setup.exe".

1、 Please select software language and click "OK" button

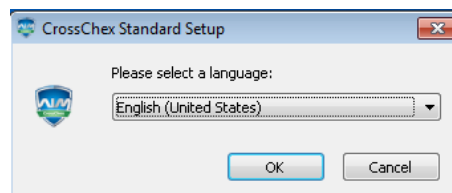

2、 Enter the software installation wizard, click "Next"

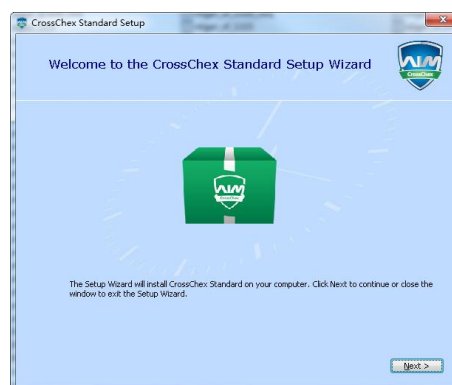

3、 Read the license terms, after the reading is complete, choose I accept the terms of this agreement. , Then click "Next".

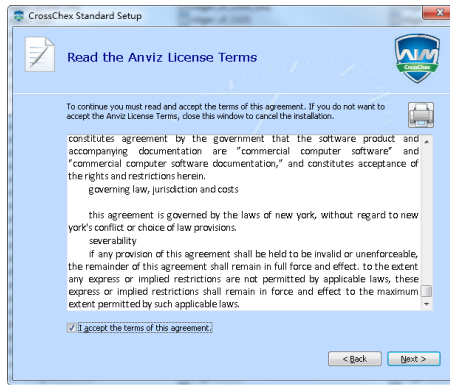

4、 Click “Browse” to select a local path as a software installation directory, if the software default path, click “Next”.

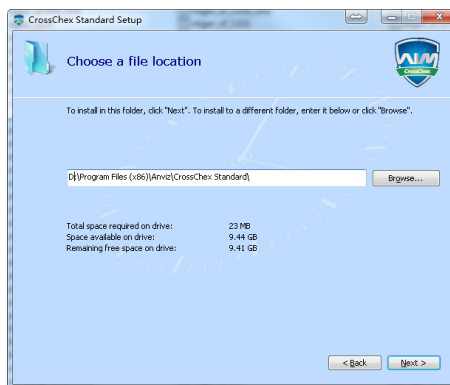

5、 Click “Install”

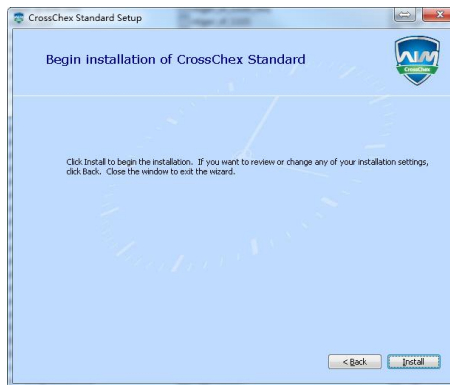

6、 Installation is in progress, please be patient, depending on the computer configuration takes about 1-5 minutes.

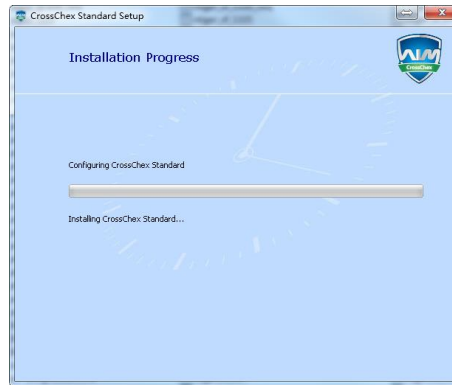

7、 The installation is complete, click on the “Run CrossChex Standard” or “close” button.

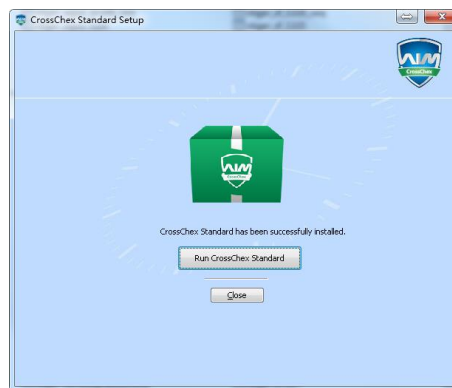

4.3 Uninstall software

This software operating system standard uninstall program, you can use the operating system platform uninstaller to uninstall, or you can use the software’s uninstaller to uninstall the following operation is complete.

- 1、 Enter into the “Start” menu, expand the “All Programs” list, find “Anviz” directory, enter “CrossChex Standard” directory, locate the “Uninstall” to uninstall the program and run (or you can enter the software installation directory to find the Uninstall uninstaller)
- 2、 Confirm whether to uninstall this software, click “Yes” to continue uninstalling, click “No” to exit.

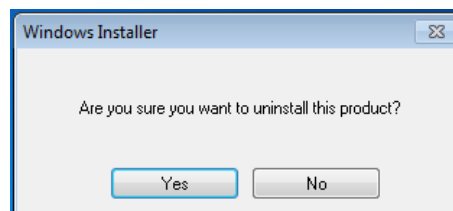

3、 Waiting for the uninstall process has been completed.

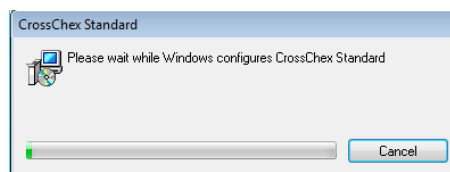

Chapter5 Communication

The chapter is mainly about how to add, delete and set communication between PC and terminal. Software features are different according to device.



5 Communication

5.1 T&A Machine Management

4.1.1 Add Unit

Go to Device tab Search and Add the P7 to management software CrossChex:

The screenshot shows the CrossChex software interface. On the left, there is a 'Device Groups' list with five entries: DeviceGroup1, DeviceGroup2, DeviceGroup3, DeviceGroup4, and DeviceGroup5. Below this is a 'Device Type' dropdown menu set to 'Fingerprint/Card Verify' and an 'Add' button. The 'Device Info' section contains fields for Device No. (2), Device ID (1), Device Name (1), Device Group (Group1), and T&A Status (Real status). The 'Communication Method' section has radio buttons for RS232 (no driver), LAN (selected), LAN (Client), RS485, and RS485 (V487), with corresponding IP and COM port settings.

On the right, there is a table of discovered devices:

No.	Device type	Device ID	Serial number	IP	Mask	Gate	MAC	SerialID	Port	Mode	Remove v...
1	P7	1	00.00.80	192.168.30.114	255.255.255.0	192.168.30.1	00:22:FF:41:71:87	19:168:097	5010	Serve	00.02.30

CrossChex software has developed its own device discovery protocol defined between the software and the device, it can remove the trouble from the device deployment configuration, realize A key installation for device configuration. Through the right side of the device can be found all LAN support discovery protocol.

Search: You can re-search the contents of all LAN device discovery protocol support.

Setting: Select from the search to the device, click on the “Settings” can be configured on the IP address of the device and other information.

Add: filling device information found in the form to the left, click “Save” to save the device to the software.

- Device No.: Users increased attendance custom number
- Device ID: PC management software is the unique identifier to identify the machine, so please pay special attention to the uniqueness of the set when the networking. Setting range: 1-99999999
- Device Name: Alias attendance from the users themselves to a different location, easy to distinguish;
- Device Group: Used to manage the terminal machine
- T&A status: Divide into three kinds of situations : real status, on duty, off duty.

Attendance is based on the actual state of the state machine on the subject terminal, attendance status set on duty or off duty attendance is not considered state of the terminal machine, attendance management program to add terminal prevail.

Communication Mode:

USB: Using a USB data cable connection

LAN: Select a network connection, the input terminal of the machine’s IP address. Please modify according to the actual situation (for network module with attendance)

LAN(Client): Device-side clients need to select the network mode, and set the server IP

COM: Serial communication port

RS485: By default, COM1 port connection

After editing is complete, click [Save] button to save the terminal information

5.1.2 Modify Unit

Select Modify terminal (tick '√' in the corresponding '□' in), click [Modify] button to open the [Terminal Management] interface:

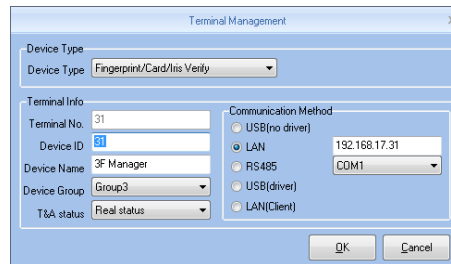

Modified according to the actual situation of the terminal information, and click [OK] button to confirm the changes; click [Cancel] button to discard the changes.

Tip: When the terminal No. or device ID is the same as existing terminal will pop up:

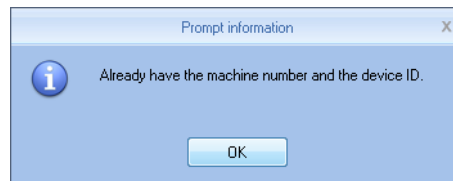

Click [OK] button to reset the machine ID or machine number.

5.1.3 Delete Unit

Select the terminal to be deleted (tick the corresponding '□' in '√'), click Delete Terminal] button, a confirmation dialog box:

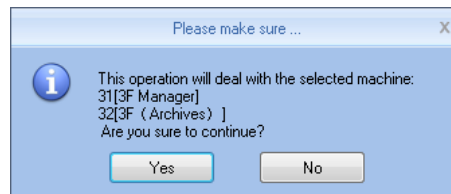

Click [OK] button to confirm to delete the selected terminal; Click [Cancel] button to cancel the deletion.

5.1.4 Synchronize Time

Synchronization time attendance machine connection time on the computer is synchronized with that. Click [Synchronize Time] button shows confirmation dialog box:

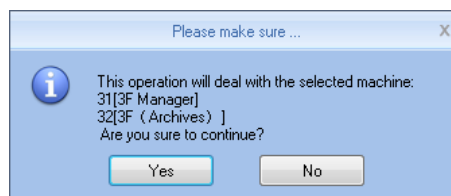

Click [OK] button to confirm the time synchronization; Click [Cancel] button to cancel

synchronization time.

5.1.5 Unit Parameter

Click **【Device Parameter】** button open the **【Terminal parameter settings】** window:

[Sleep time]: Attendance from unattended to go to sleep interval, 0 means not hibernate, maximum sleep time was 250 minutes

[Volume]: Attendance voice prompt volume level, 0 represents the mute, the maximum volume of 5

[Date format]: Attendance in the date format, there are about several formats:

yy-mm-dd(year-month-day), mm/dd/yy(month -day-year), dd/mm/yy(day-month-year)

[Time format]: Attendance, the time display format minute 24-hour and 12-hour two kinds

[Matching precision]: normal, good, exact three levels, the default is good. The higher accuracy of fingerprint requirements are also higher

[Record alarm threshold value]: When the attendance record set record number is greater than the alarm threshold value, the machine will prompt the user to make the appropriate alarm processing. 0 means no alarm, you can set the maximum number of records in 5000.

[Time period between repeated clocking]: The interval between the same user twice attendance, 0 indicates no interval, the maximum interval is 250 minutes. Attendance during the interval times, the system records only one record.

[Workcode prompt]: Work code function is enabled and disabled.

[Intelligently update the fingerprint template]: Fingerprint comparison on the process, it can automatically replaces the previous low-quality storage of fingerprint data for the new high-quality fingerprint data acquisition, thereby maintaining the latest fingerprint data, to avoid

duplication of authentication of users. The default is disabled.

[Ring function]: It is disabled by default, according to the actual needs of their own settings (This feature applies to support a bell function of the model).

[Wiegand Mode]: There are two modes: Encrypted Anviz wiegand, wiegand 26, fixed wiegand area code and card number mode wiegand. Default Wiegand 26 (for supported Wiegand outputs of attendance).

[Fixed Wiegand area code]: If you upload the same fingerprint ID number to two different machines than by wiegand signal output after the number will be different. Wiegand code set at this time if these two machines of the same words, wiegand signal output on the same number.

[Relay time]: Means connected with the lock to open the door after attendance by relay. The maximum delay of 15 seconds (for support electric lock signal output attendance).

After setting, click [OK] button to save the settings.

5.1.6 Access Setting

Group management for door open timetable support access control function support devices, This function is only for the terminals which have the access control output.

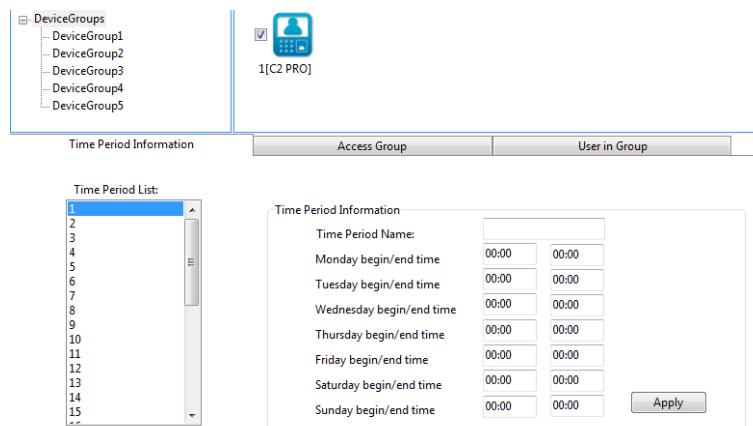

Anviz crosschex software support 32 access control timetable and 16 access control group, one group support 4 timetables, the target is to setup access timetable to staff, and connect all timetable to a access rule, and give rights to the according staff.

Steps to setup:

1、Setup time zone list:

In the list, show first timetable: 1-Day,

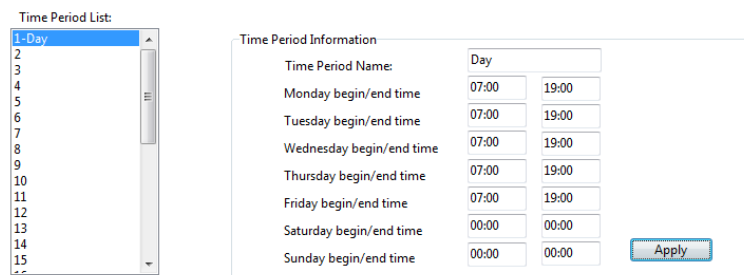

The time list show Monday to Friday, 7: 00—19: 00, in this period, the staff could accessed. You can change and set the according 32 time zone and Apply to the system.

2、Setup access group:

In the list has '0-NC Group' and '1-NO Group' could not be modified.

0-NC Group: All the staff in this group could not be accessed anytime.

1-NO Group: All the staff in this group could be accessed anytime.

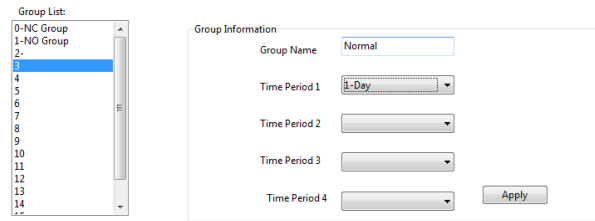

The Administrator could define the other group information:

Group name: Input name

Time zone: Choose according number

Press **【Apply】** to save the update.

3、 User in Group

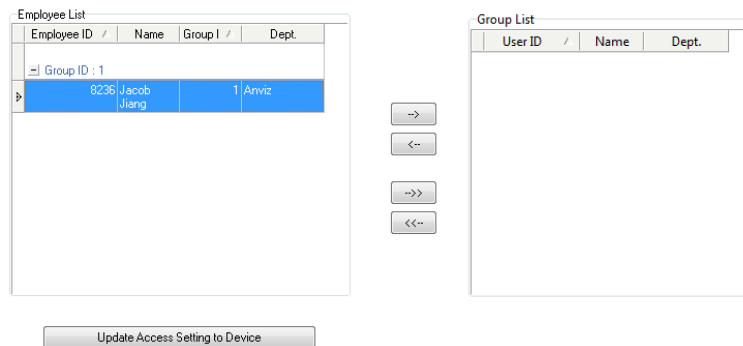

Choose the staff at User list, hit “-->” to move to right part or press “-->>” move all staff to ‘employee in group’ and also realize staff by “<--” or “<<--” , Hit **【Update Access Setting to Device】** upload the group to the device.

5.1.7 Download New Records

New attendance record is to read the new record in attendance after the last collection record read out, save it to your computer.

Click [Download New Records] button message box pops up:

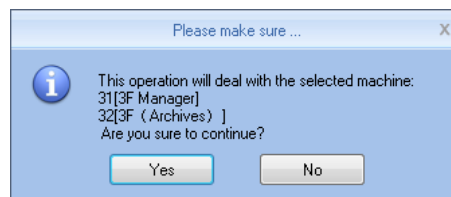

Click on [Yes] button to start reading the record; click [No] button to abandon the operation.

5.1.8 Download All Records

Download all attendance records is to save all the attendance records to the computer table.

Click [Download All Records] button message box pops up:

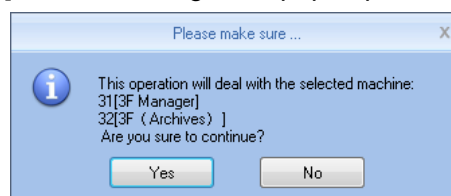

Click on [Yes] button to start reading the record; click [No] button to abandon the operation.

5.1.9 Backup User

Backup employee refers to staff information and fingerprint information stored in attendance download and save to your local computer for backup.

Click [Backup User] button message box pops up:

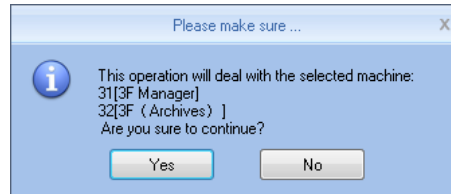

Click on [Yes] button to confirm and start downloading personnel data, click [No] button to abandon the operation.

5.1.10 Resume User

Resume User refers to the use of all personnel software registration information and fingerprint information uploaded to the attendance of local computer database.

Click [Resume User] button message box pops up:

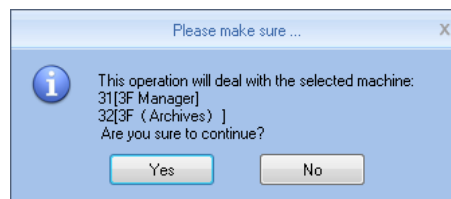

Click [Yes] button to confirm and start the upload personnel information; Click [No] button to abandon the operation.

5.1.11 Activate Realtime

Real-time monitoring means that the function within open time on attendance records to verify information can be displayed in real time in the recording list.

5.2 Record Management

The main check on attendance records and backup.

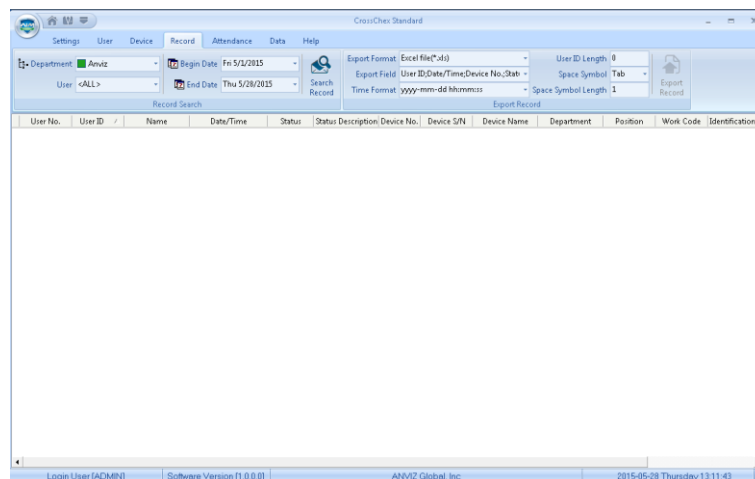

5.2.1 Search Record

Records Search is the records that meet the search criteria is retrieved.

Drop-down button to set the record you want to check the start date and end date, you can click the input box after selecting date

After setting the record date Click [Record Search] button, verify records that meet the criteria will appear in the record list:

Employee No.	Employee ID	Name	Date/Time	Status	Status Description	Unit No.	Unit S/N	Unit Name	Department	Position
8795	8795	Brain	2015/5/19 12:56:29	1		25	25	2F.	America	

5.2.2 Export Record

Make the attendance record for backup.

Set export the contents of the record export format:

Export Formats: There are three formats optional: text file (.txt), CSV file (.csv), Excel file (.xls).

Export field: Users can choose their own needs important fields to export, or select all.

Time Format: There are four kinds of time formats to choose from.

Staffer No. length: Length is set in the exported file in staff numbers, the default is 4.

Symbol interval: Delimiter between fields and field.

Space symbol length: Space symbol digits.

Set up an export conditions, click [Export Record] button, open the “Save As” dialog. Choose to save the file, enter the file name, as shown below:

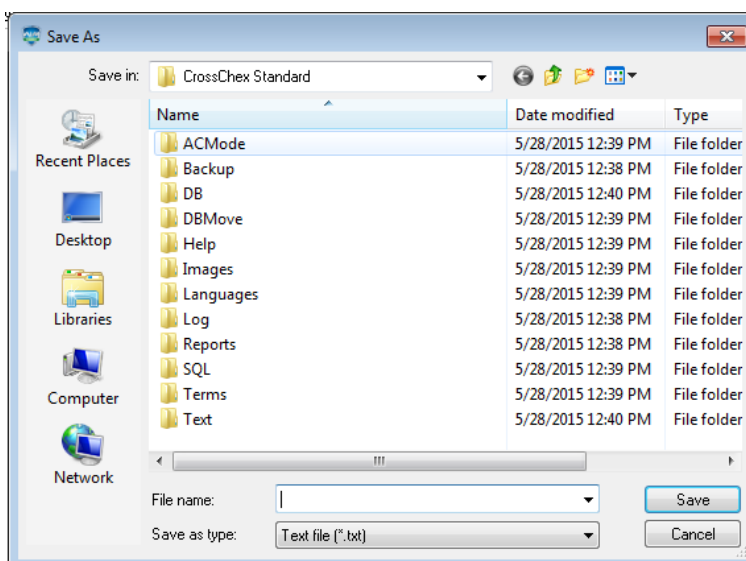

Click [Save] button to save the file, you will be prompted to save the completed information system:

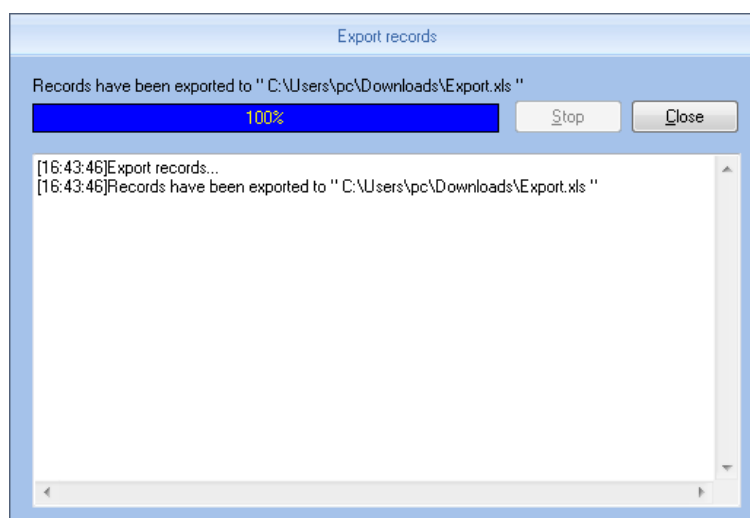

5.3 User Management

User management includes user information for the add, edit, import, export and so on the operation.

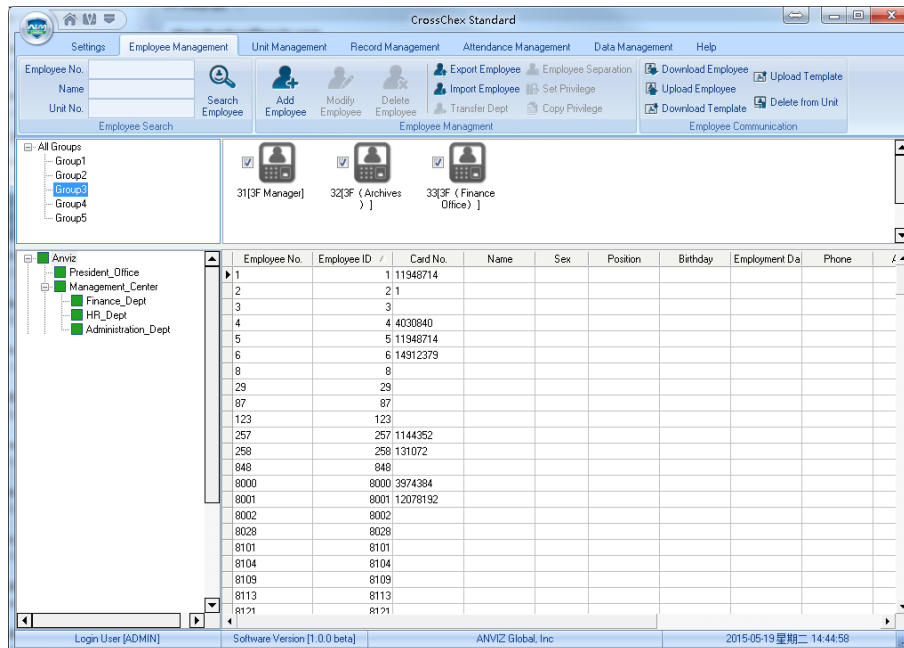

In the upper left corner of the user management menu, you can search user by clicking **【Search User】** button through entering user number and name. And you can click the other menus to modify, delete, upload, download and other operations for the user you selected.

5.3.1 Add user

Click menu **【Add】**, pops up 'Add / Modify User Info' form:

- 1、 You can enter user information according to the field of this information form, the red field is a required field
- 2、 ID On device support 8 digit number, User No. support 20 digit number.

- 3、 The ID On device and User No. is the unique identification of an employee, they cannot repeat and the first number cannot be 0
- 4、 Application of ID On device and User No. is mainly convenient the data format which client exported to be flexible meet the third-party software import.
- 5、 Group number: Refers to the access control group. We can set the employees which access group they belong to.
- 6、 User type: you can choose normal user or administrator.
- 7、 Identification: Anviz intelligent attendance devices support multiple identification verification. Employees can choose which identification verification to use in hardware
- 8、 Software support employee to add photo from the local computer, or directly through the camera to take photos.
- 9、 Select the photos on the local computer. Click  button to open the **【Edit picture】** window:

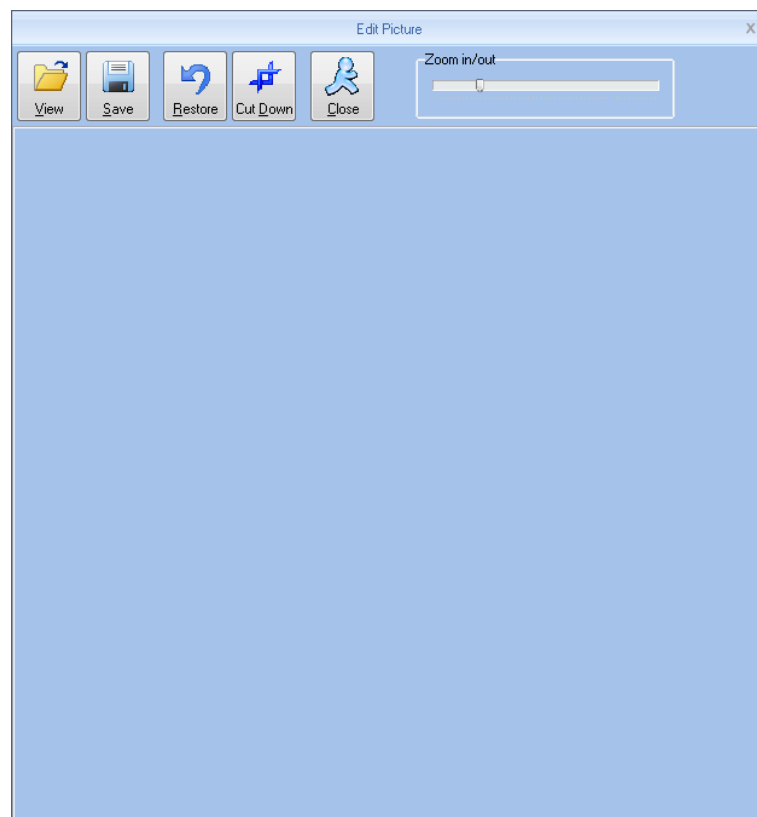

Click the button [View], “pops up open dialog box to Select employee photo, click [Open] button to open, use the mouse to select the area as a photo also can use your mouse to drag the picture to their new size:

- 1, Zoom in out:



After Set is finished, firstly click the [Cut Down] button and then click [Save] button to save the employee photo and return to the [Add / Modify User Info] window.

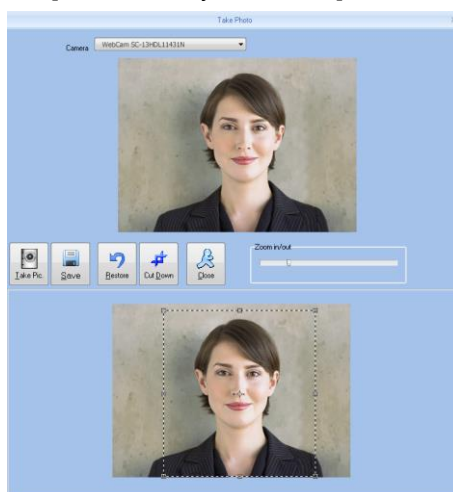

2, Take photos.

Click  button to open [Take Photo] window, as the picture shows below:

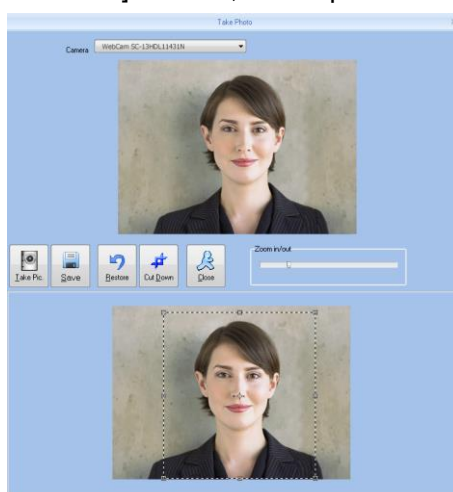

Adjust the image, Click [Take Pic.] button to take photos for employees. The photo took by you will be displayed under the window, use the mouse to select the area for cut down click [Cut Down] button to cut down photo. The same photo process method with the previous one.

Click **[✕]** button to delete employee photo.

Attendance statistics related: new employee attendance rules set up directly.

Default work schedule of the new employee: set the default work schedule of the new employee

5.3.2 Modify user

Modify user is to modify user information in the data sheet.

Select the record that need to modify from the list of user information, click the button [Modify] or simply double-click the user records can open [Add / Modify User Info] window to modify user information .

Modify is finished click [Save] button to save. Specific operation may refer to add user step.

5.3.3 Delete user

Delete user is to delete user information from the data sheet. From the list of employees you can select the record that need to delete by using [shift] or [ctrl] button. click [Delete] button pops up confirmation dialog box:.

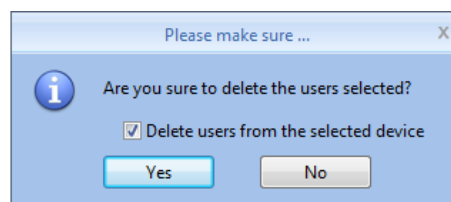

Click [Yes] button to confirm and start to delete the selected information; click [No] button to cancel this operation.

Choose 'Delete users from the selected device' to delete the employees in the database at the same time will also delete user information that saved on the device.

Note: when the user information was deleted from the device, it will be deleted completely. Please select this for necessary action.

5.3.4 Export users

Export selected user information from the list of users, in the format of excel export the user Information form.

Click [Export] button the following dialog box pops up:

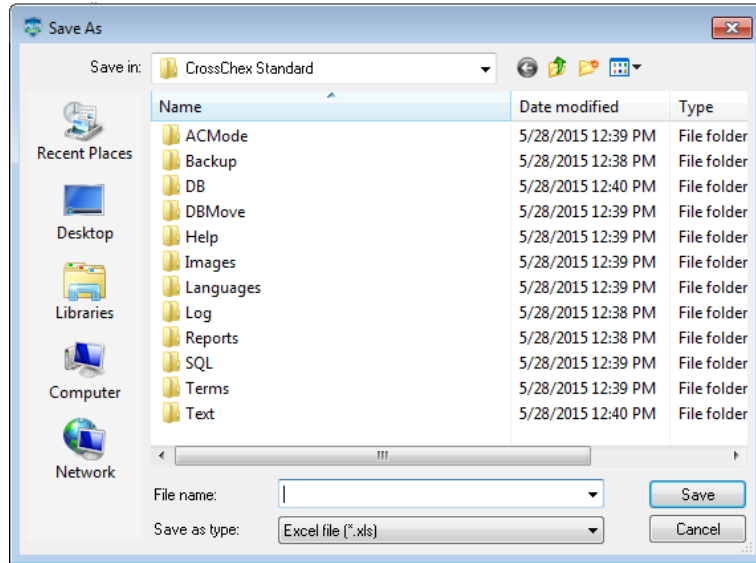

Select the path to export excel file.

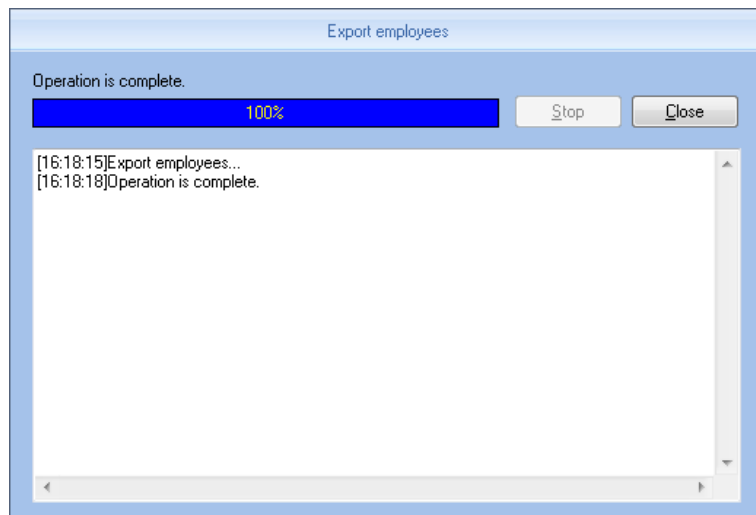

After operation is finished click [close] to complete the export.

5.3.5 Import user

Through the prescribed format of EXCEL To import the user information

Click [Import] button, pops up EXCEL file path select dialog box :

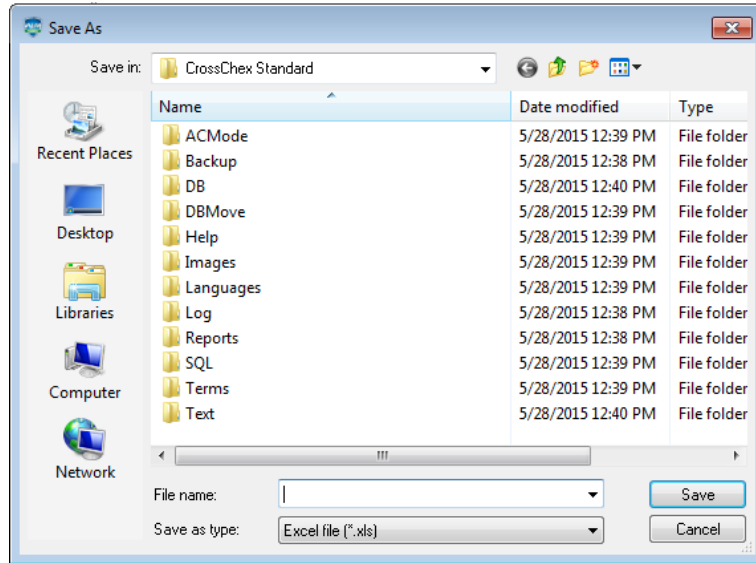

select the Excel file you need, click [Open] button the following dialog box pops up:

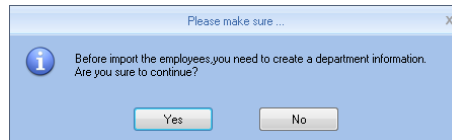

Click [Yes] to confirm [No] to give up. After Import is finished click [Close] to complete the import.

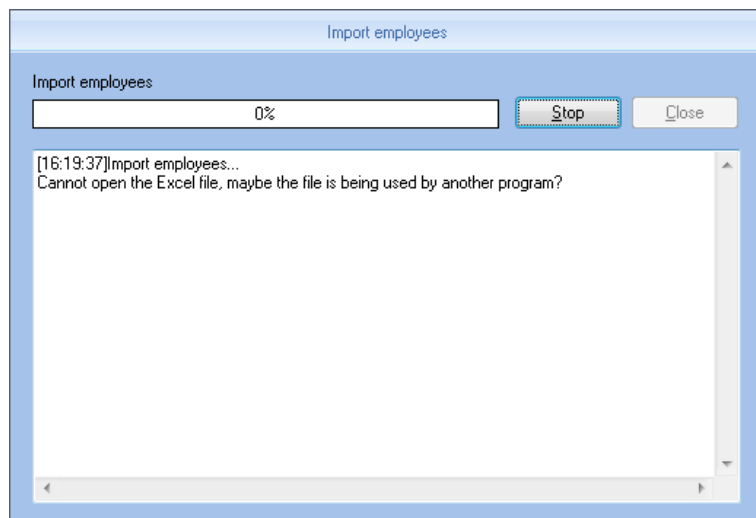

5.3.6 Transfer Dept

When HR adjustment come, need to replace the employee department, [Transfer Dept] function: can transfer users between different departments from the list of users you can select the user whom need to transfer department by using shift or ctrl button. click [Transfer Dept] button open the [User Transfer] window as the picture shows below:



Select the department click [Ok] button to save the information, click [Cancel] button to give up this operation.

5.3.7 Employee Separation

This operation will put user to the separating user column not to delete information directly and the information will be saved and backup for HR department or management department select the user who is going to separate from the list of users, click [Disabled], pops up the following window:

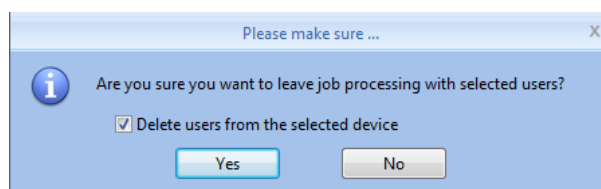

Select 'Delete users from the selected device' the user information will be deleted from the device. Also put this user to the separating employee.

The user who is in the [Disabled], can return to the company by transfer department.

5.3.8 Set Privilege

Set privilege means to set storage privileges for employees on the device.

From the list of employees, you can select the record that need to set privilege by using [Shift] or [Ctrl] button click [Set Privilege] button open the [Set Privilege] window :

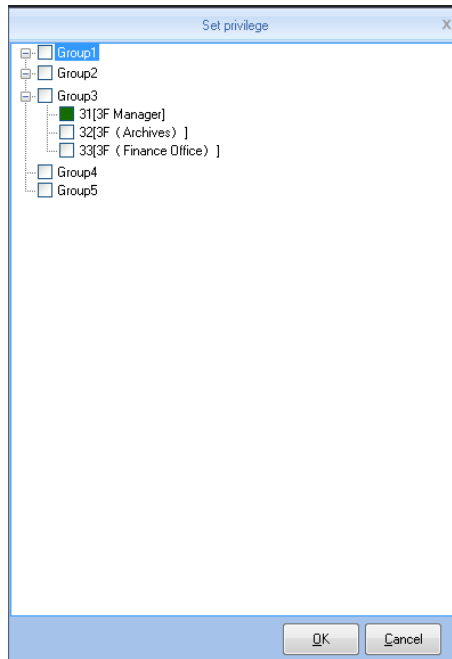

Tick what you need, click [OK] button to save the privilege.

Look at the staff list [Unit No] and you can see selected employee machine number has been updated to the selected number.

5.3.9 Copy Privilege

Copy privilege is to copy the storage privilege and administrative privileges of employees, and then copy to the other employees, they will be unified set with storage and management authority.

From the list of employees you can select the record that need to copy privilege by using [Shift] or [Ctrl] button click [Copy Privilege] button to open the [Copy Function and Privilege] window:

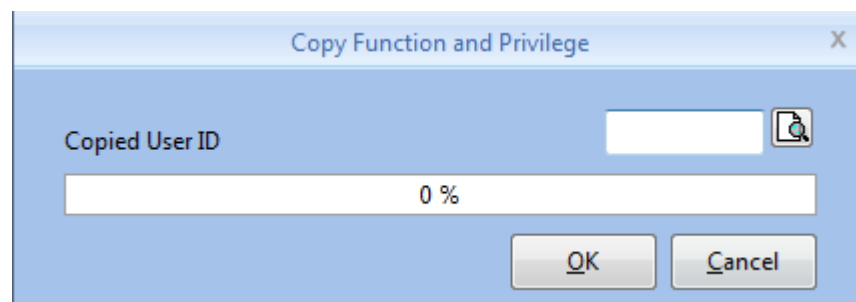

Input the number of who is going to be copied If you don't know the privilege of him, click  button to open the [Set Privilege] window to view his settings:

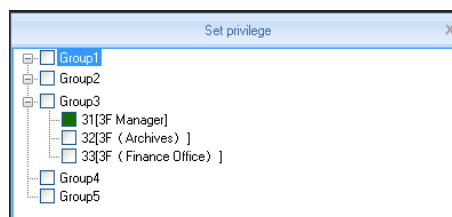

At this moment, is not able to modify privilege.

after viewing the employee's settings Click [No] button return to the [Copy Function and Privilege] window, click [Yes] button pops up the confirmation dialog box:

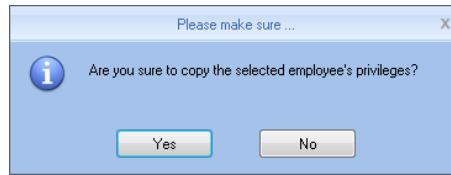

Click [Yes] button to confirm and start copying the employee privilege click [No] button to cancel this operation.

After copy is finished pops up prompt information window

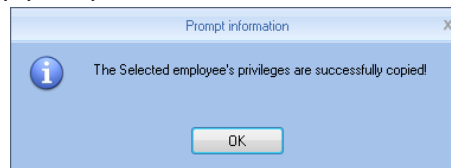

Click [OK] button to confirm the completion

5.3.10 Download user

Download user refers to download the user information and template information which was saved in the attendance machine to local computer for backup

Click [Download User] button pops up confirmation dialog box:

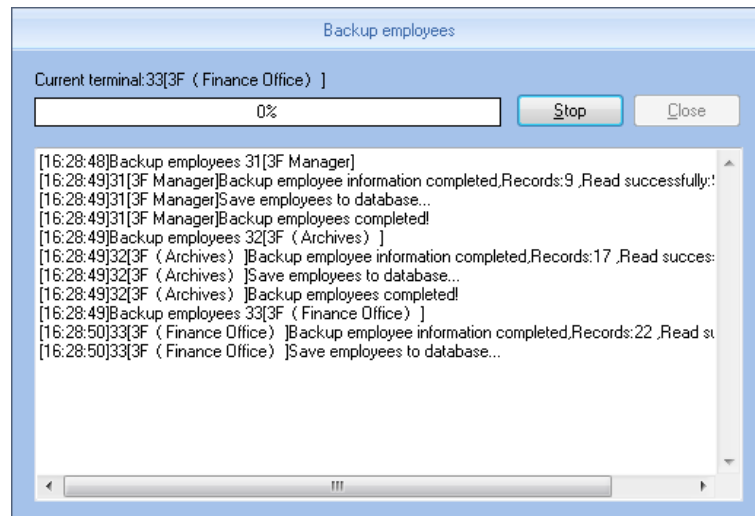

While downloading user firstly backup users data then backup Fingerprint information . after download is finished, you can see all the user information in the list of users. Also you can know the registration information in the device, Such as 'Password' 'fingerprint' etc.

Employee No.	Employee ID	Card No.	Name	Sex	Position	Birthday	Employment Da	Phone	Address	Unit	Password	FP 1	FP 2	Face	Ir
1	1	11948714								1	<input type="checkbox"/>	<input checked="" type="checkbox"/>	<input type="checkbox"/>	<input type="checkbox"/>	<input type="checkbox"/>
2	2	1								1	<input type="checkbox"/>	<input type="checkbox"/>	<input type="checkbox"/>	<input type="checkbox"/>	<input type="checkbox"/>
3	3									1	<input type="checkbox"/>	<input type="checkbox"/>	<input type="checkbox"/>	<input type="checkbox"/>	<input type="checkbox"/>
4	4	4030840								1	<input type="checkbox"/>	<input type="checkbox"/>	<input type="checkbox"/>	<input type="checkbox"/>	<input type="checkbox"/>
5	5	11948714								1	<input type="checkbox"/>	<input type="checkbox"/>	<input type="checkbox"/>	<input type="checkbox"/>	<input type="checkbox"/>
6	6	14912379								1	<input type="checkbox"/>	<input type="checkbox"/>	<input type="checkbox"/>	<input type="checkbox"/>	<input type="checkbox"/>
7	7	2646883792								1	<input type="checkbox"/>	<input type="checkbox"/>	<input type="checkbox"/>	<input type="checkbox"/>	<input type="checkbox"/>
8	8									1	<input checked="" type="checkbox"/>	<input type="checkbox"/>	<input type="checkbox"/>	<input type="checkbox"/>	<input type="checkbox"/>

5.3.11 Download user

Download template refers to download the user fingerprint information that was saved in the attendance machine to local computer for backup. You need to select the user who is going to download template from the list of users, click [Download Template] button pops up

confirmation dialog box:

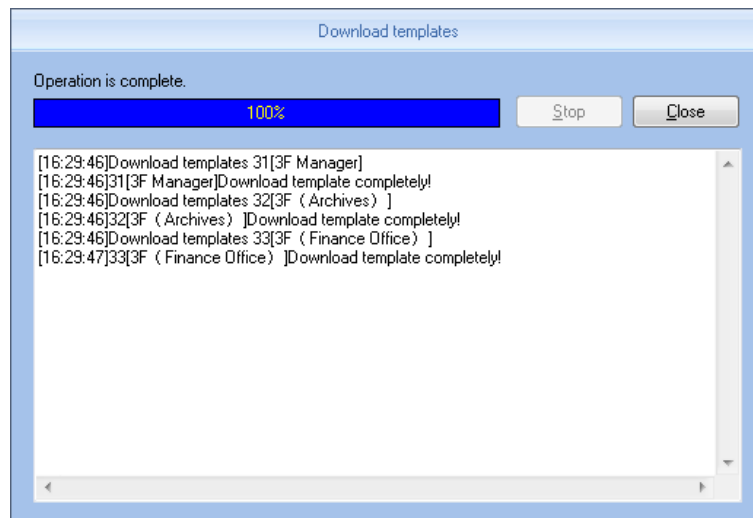

After download template is finished, you can see the column of download template fill color. That means the fingerprint has been downloaded.

5.3.12 Upload template

Upload template mainly refers to upload the fingerprint information that was saved in the database to corresponding Attendance device, this function mainly used for sharing user information between two devices. or by using fingerprint collection device U-BIO to collect fingerprint template, then upload to the device you are going to use..

select the employee who is going to upload template from the list of users. click [Upload Template] button:

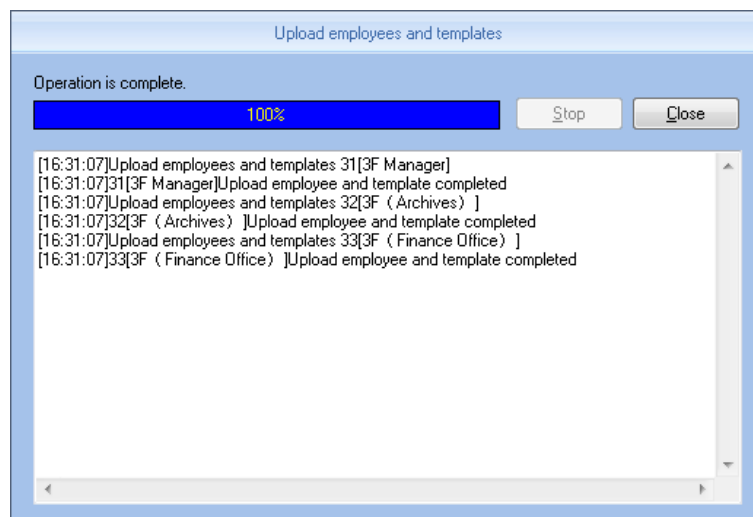

when upload template is finished, the user can do fingerprint identification with the device that uploaded the fingerprint

5.3.13 Delete from device

Delete from device refers to delete user information in the attendance machine through software.

From the list of users you can select the record that need to delete by using [Shift] or [Ctrl]

button click [Delete from Unit] button The following dialog box pops up:

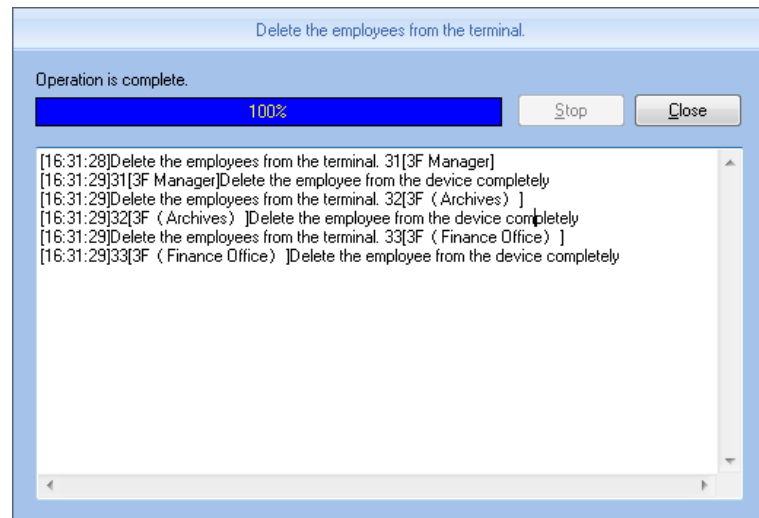

To delete the user information in attendance machine.

Chapter6 Background Management

The main theme of this chapter is how to collect attendance records from different terminals with management software and generate different reports. The background software can manage staff information, set rules of attendance, etc.



6 Background Management

Management software can collect attendance records from different terminals, calculate according to shift setting and finally generate different reports. The background software can manage staff information, set rules of attendance etc.

6.1 Log In System



Double-click desk icon **CrossChex Standard** or click the software “CrossChex Standard” from menu directory “Start”- “All” –“Anviz”- “CrossChex Standard”. Once loading over, it will show a window below:



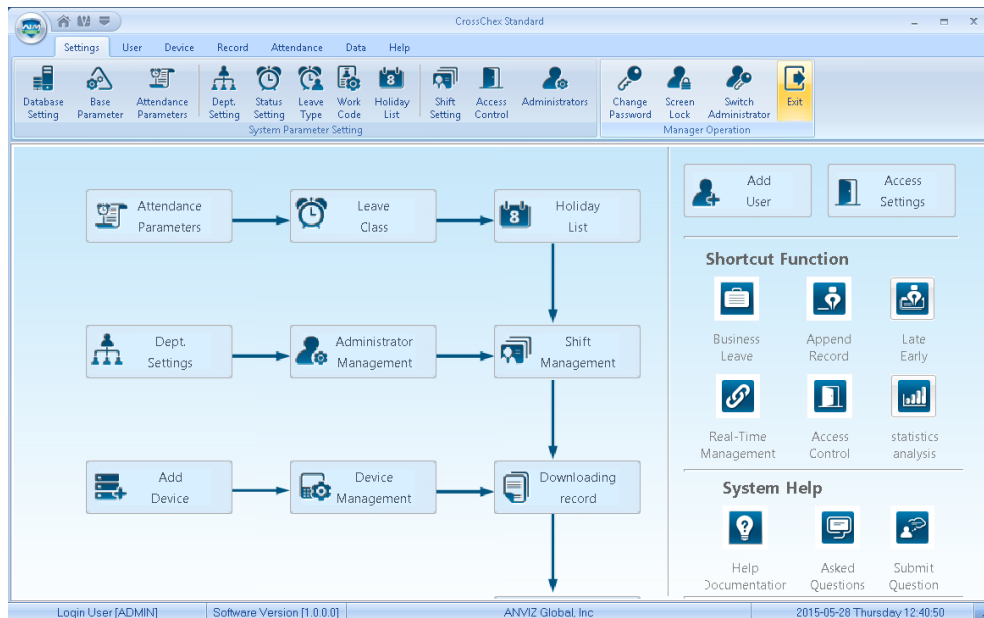

Default User name: ADMIN. Empty password. Press “confirm” to entry. Press “Cancel” to close. Anviz Biometric management software interface is divided to 3 parts:



1) Window setup



Picture	Name	Function
	Home page	Click on the icon, the software will be returned directly to the main interface.
	Skin	System supply 3 skin color: blue, black and silver.
	Language	Click on the icon can switch software language

2) System Function

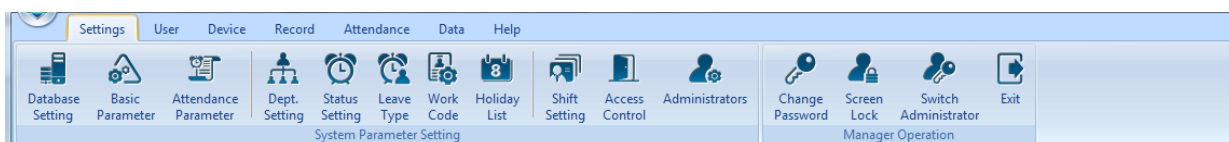

Name	Function
Settings	Set all the system parameters, such as attendance, access control, system parameters, etc.
User	User information to add, modify, upload, download and so on.
Device	Communication with device, uploads and downloads from device.
Record	Screening and searching records according to the attendance record.
Attendance	Searching attendance records and generate report.
Data	Import and export of data, backup database, operation log, etc.
Help	Software version information, online upgrade, etc.

3) Quick interface

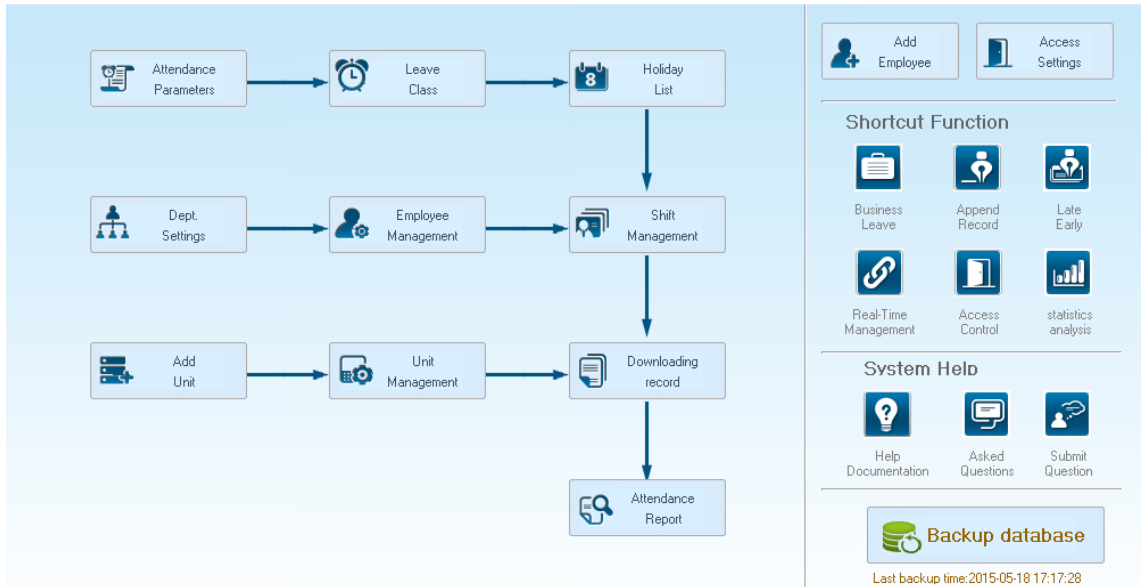

On the left is based on the normal operating procedures of the menu, more convenient and familiar software attendance processes; the right side is common functions as an icon is placed in the main interface, convenient for system administrators to quickly operate.

6.2 System settings

System settings include database setting, base parameter, attendance parameter; dept. setting, status setting, leave class, work code, shift setting, access setting, user setting, modify password, lock manager ect.

6.2.1 Database Setting

Anviz Biometric management software, with default Access database, SQL Server data supported.

Can be optional changed by the admin.

Access

Access File: D:\Program Files (x86)\Anviz\CrossChek Standard\DB\Cross: ...

Sql Server

Server IP:

User Name: sa

Password:

Database Name: Att2012

Access Database:

Display database file storage path, press “”, choose other mdb data files.

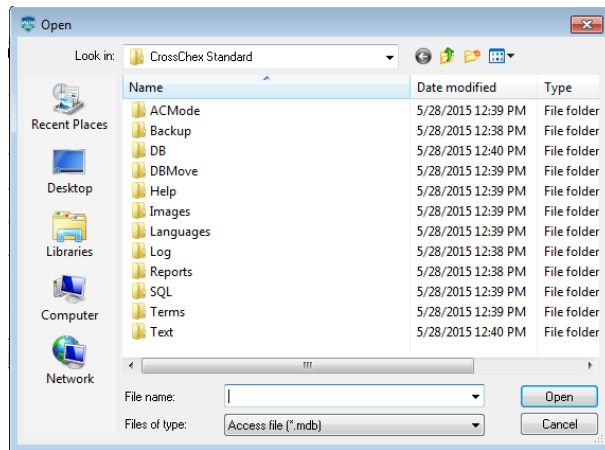

SQL Server Database:

(Installed MS-SQL Server software is a plus before SQL Server operation)

Server IP: Please entering the Server IP address of MS-SQL Server database.

User name: Setting when MS-SQL Server database installation.

Password: Setting when MS-SQL Server database installation.

Database name: Default as "Att2012"

Press "Apply". Anviz Biometric management software will generate related database in MS-SQL Server database.

6. 2.2 Base Parameter

Base Parameter include 4 parts, "Employee field content editing", "Custom field setting", "Communication parameters" and "Downloading record"

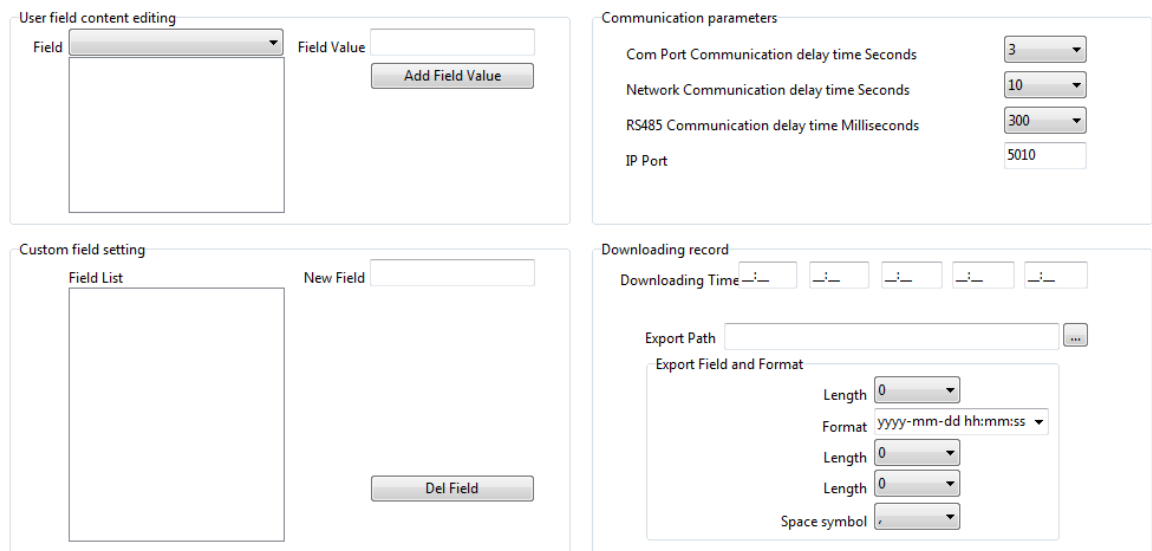

User Field content editing:

Add in 'Position', 'Education', 'Specialty', 'Language' and 'Marital Status'

Field Value: Entering the content.

Example, when you selected 'Language' and entered in 'Spanish", press 'Add Field Value'. Then 'Spanish' will be shown in 'Language' field.

The interface is titled "Employee field content editing". It features a dropdown menu labeled "Field" with a downward arrow. Below the dropdown is a large empty rectangular box. To the right of the dropdown is a text input field labeled "Field Value". Below the "Field Value" input are three buttons: "Add Field Value", "Del Field Value", and "Clear Field Value".

Del Field Value: Select the field in the list, and press 'Del Field Value'. Then the selected field will be deleted.

Clear Field Value: Click 'Clear Field Value', all fields in the list will be cleared.

Custom field setting:

The interface is titled "Custom field setting". It has a "Field List" section on the left containing a list with one item: "Birthday". To the right is a "New Field" section with a text input field and an "Add Field" button. Below the "Field List" are two buttons: "Del Field" and "Clear Fields".

Convenient admin to add in fields with more user information. The field can be effected in 'User' – 'Add'.

New Field: Add in new field name.

Press 'Add field' to add the field into the page 'User'- 'Add'

For example, entering the field "Marital status" into the list. Then it will be shown in the 'User'- 'Add'.

The dialog box is titled "Add/Modify Employee Info" and has two tabs: "Basic Info" and "Custom Fields". The "Custom Fields" tab is active, showing a table with two columns: "Field Name" and "Field Value". The table contains one row with "Birthday" in the "Field Name" column. Below the table is a large empty rectangular area. At the bottom of the dialog, there is a red text note: "Note: the red items are required!". To the right of the note are "Save" and "Cancel" buttons.

Communication parameters:

Set up communication between ANVIZ biometric management software and device parameters.

Communication parameters

Com Port Communication delay time Seconds	3
Network Communication delay time Seconds	10
RS485 Communication delay time Milliseconds	300
IP Port	5010

Apply

Serial communication timeout: When using a serial connection and communication hardware, software and hardware to allow communication delay, when the software and hardware devices are not creating a connection, the communication system within the allowed time delay will prompt communications failure, or the device is not connected. Timeout range that can be set: 1-5 seconds, Default: 3 seconds

Network Communication delay time:

Setting software/hardware delay time when communicate with devices by network. Once connection failed in setting delay time, system will notice the failure or not of connection. Setting range: 1-10 sec, default, 10 sec.

RS485 Communication delay time:

Setting software/hardware delay time when communicate with devices by RS485. Once connection failed in setting delay time, system will notice the failure or not of connection. Setting range: 200-500 Millisecond, default, 300 Millisecond.

IP Port:

The port IP for software/hardware data transmission when communicate with network and hard device.

(Remark: The port IP must be uniformed on software and hardware network communication port. Or the communication will be failed. To setting the port IP, please refer to the instruction for the hardware setting.)

Press 'Apply'. The setting will be kept and applied.

Timing Downloading Record:

Anviz biometric management software supports five times Point Timing download attendance records, and can be exported to a text file. Facilitate customer attendance record will be imported into ERP and other third-party software.

Downloading record:

5 downloading time supported. Auto-download attendance record.

Remark: Anviz biometric management software cannot be closed when downloading working.

Once downloaded automatically exported to a text file: for the convenience of customers attendance records into the ERP and other third-party software, select “After the download is completed automatically exported to a text file,” the timing of the text and attendance software, save to the designated storage path, and you can select the software provided under content, customers can compile the required attendance record text file based data format required third-party software.

Press “Apply”. The setting will be kept and applied.

Automatically backup the database when exiting the program.

Automatically backup the database when exiting the program.

Effected this function, when exiting the program, the database will be backup into the folder ‘Backup’ under installation directory.

6.2.3 Attendance Parameter

Attendance Parameter includes two parts of ‘Stat. Rule’ and ‘Stat. Items’

The screenshot displays two configuration panels for attendance statistics. The left panel, titled 'Stat. Rule', includes fields for 'A workday count as' (480), 'The shortest working time' (10), and 'The longest working time' (720), all in minutes. It also features options for 'minutes earlier clock-in count as overtime' (30) and 'minutes later clock-out count as overtime' (60). Below these are sections for 'Weekend' (checkbox), 'Shift covers two days' (checkbox), and 'Overtime Calculation' with rates for Normal (1.00), Weekend (2.00), and Festival (3.00). The right panel, titled 'Stat. Items', shows a list of items including Normal, Late, Early, Business Leave, Leave, Absence, Stay away, Overtime, and Free Overtime. The 'Normal' item is selected. To its right, a 'Stat. Rule' sub-panel shows 'Unit Set' (Day), 'Unit' (Day), 'Minimum' (0.5), 'Round-off control' (empty), and 'Indicating Symbol' (/).

Stat. Rule:

Setup the role of attendance statistics

A work day count as: This value will be used as a constant value of late / early to leave / free overtime / statistical project which calculate work hours of constant value. The Parameter range: 60-1200 min(default 480 min)

The shortest working time: In the statistical report, the minimum effective time intervals for constantly punch card records , lower than this time interval will be ignored for participating statistics.

Parameter range: 1-480 min(default 10 min)

The longest working time: In the statistical report, the maximum effective time intervals for constantly punch card records , longer than this time interval will be ignored for participating statistics.

Parameter range: 60-1440 min(default 720 min)

Not clock in count as late: Forget work attendance, attendance recognized by the system for the day how many minutes late, as the punishment for forget to go to work

Parameter Range. : 1-480 min(default 60 min)

Not clock out as early: No attendance record for being late to work: forget work attendance, identified by the system for the day and leave early attendance how many minutes, as a sign of punishment for forget work

Parameter range: 1-480 min(default 60 min)

On duty X minutes earlier clock-in count as overtime: A statistics way for overtime, will be recorded as record in this time range before the normal clock-in time

Parameter Range: 0-480 min(default 30 min)

Deduct the on duty X minutes earlier: Deduct the above recorded time as the over work time.

Off duty X minutes later clock-out count as overtime: A statistics way for overtime, will be recorded as record in this time range before the normal clock-out time

Parameter range: 0-480 min(default 30 min)

Deduct the off duty X minutes later: Deduct the above recorded time as the over work time.

Weekend: setup the fixed weekend, default is Saturday and Sunday.

Shift over two days: When the time over 00:00 AM, choose this record for the 1st day or 2nd day.

Overtime calculation: Setup the overtime rate for normal, weekend and festival

Hit 'Apply' and all the setup would be updated into the system.

6.2.4 Dept. Setting

Setup company name, department and organization structure.

Add department:

Select a department need to add sub-dept. Hit add, and input the department name at the blank, and choose save.

Notice: if you need do any operation for the new added department, please firstly go to 'Admin setup' to add the operation rights(choose the department at "operational Dept.

Modify Department:

Choose the department, hit: 'Modify', input the name in the blank and press save.

Delete department:

Choose the department, hit **【DEL】** , Press confirm at the blow window.

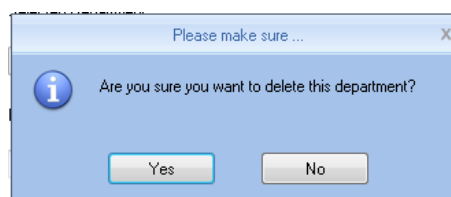

Notice: 1、 The department name could not be repeated.

2、 if there has staff at deleted dept., the would be added to headquarter automatically.

6.2.5 Status Setting

The fingerprint devices provided by Anviz Global support 16 attendance status, and all the client could customized setup the attendance status.

Status value	Symbol	Status Description
0		In
1	1	Out
2	2	2
3	3	3
4	4	4
5	5	5
6	6	6
7	7	7
8	8	8
9	9	9
10	10	10
11	11	11
12	12	12
13	13	13
14	14	14
15	15	15

Status value: Value for 16 different modes。

Symbol: This symbol is matching with hardware setup, not suggest to modify.

Status description: Customers can describe the required attendance status, write in here. This description can be synchronized to the device (different models have different character bits wide limit)

Choose the above device and hit: 'upload to the selected terminal' to update the devices.

Notice: Attendance must be completed in accordance with the state of the state number order.

6.2.6 Leave class

Setup the leave type, use different colors, like annual leave, marriage leave

Leave class information:

Name: Input name, like annual leave

Color: Choose one color

Stat. Rule: Setup the time unit

unit: Day, hour, minutes

Minimum: Support minimum or 0.5 hour and 1 minutes.

Round-off control: Refer to round-off control in the Attendance Parameter

Indicating symbol: The symbol would be used to mark leave in the report

Count as leave: Count such data into the leave field in the report

Press **【ADD】** to add the name and color into leave class list

Choose item in 'Leave class list', hit **【Modify】** to save changes

Choose item in 'Leave class list', hit **【DEL】** to Delete the item

6.2.7 Work Code

Anviz global provide fingerprint devices which supports multiple types of settings. An employee may work in a different identity attendance, for easy to calculate attendance statistics with appropriate time and payroll. Click page [Leave class], following shows

Work code information:

Number: Input number.e.g.: 9527

Name: Input name.e.g.: financial, IT, etc.

Unit: Day, hour, minutes

Minimum: Support minimum or 0.5 hour and 1 minutes.

Round-off control: Refer to round-off control in the Attendance Parameter.

Press **【ADD】** to add the name and color into work code list.

Choose item in 'work code list', hit **【Modify】** to save changes;

Choose item in 'work code list', hit **【DEL】** to Delete the item.

6.2.8 Holiday List

Setup holiday list and will automatically show on report

Holiday information

Name: Input name

Start date: Choose start date

Dates: Add dates

Press **【ADD】** to add the name and color into holiday list

Choose item in 'holiday list', hit **【Modify】** to save changes

Choose item in 'holiday list', hit **【DEL】** to Delete the item

6.2.9 Shift settings

The key function, and realize shift setting by three steps.

Time table setting:

Setup working time period, means the time from start work till off work, e.g. Working time: 08:00-12:00AM and 13:00-17:00PM, then we have two time table, if you need add a shift, should have these two time table, and refer to below two parts for details. Here we just know something about relationship with shift and time table.

[Time table name] category of the shift, e.g.: Day work

[on duty time] start working time, e.g.: 09:00

[Off duty time] off work time, e.g.: 17:00

[Begin Clock-In time] effect record after this time. e.g.: 07:00

[End-clock in time] ineffective record after this time e.g.: 13:00

[Begin Clock-Out time] effective work out record after this time e.g.: 16:00

[End Clock-Out time] ineffective work out record after this time e.g.: 02:00

[Late error allowance] e.g.:5, then the record before 9:05 would not be treated as late.

[Early error allowance] e.g.:5, record after 16:55 would not be treated as early

[Count As Work Day] statistics unit for the report. e.g.

[Count As Work Time] e.g.: 480 (Work time is auto setup by time table)

choose[Must C-In] and [Must C-Out], hit **【Save】** button to add the table

Notice: Each item should be setup and empty item is not permitted. On duty time and Off duty time could cross date, but could not have a different over 24 hours.

[Count As Workday] and [Count As Work Time] should be used on work leave, over work, etc. Should be setup accurately.

If you choose [must C-In] and [Must C-Out] will effect the result, If some staff has this time table in his shift, and he is not clock-in and applied for leave, then will be treated as absence, if not choose these two item, then if this staff only clock out and no clock in, will still be treated as normal.

[Free time]: Match the clock zone in system, only calculate time, not mark early or late.

[OT-time]: Marked whether this item used as over work.

Modify timetable:

Choose name, input new content, press **【Modify】** to change.

Delete timetable:

Choose the timetable, Press **【DEL】** and confirm at following window to delete.

Note: Begin Clock Time and End Clock Time makes the valid time range, the record not in the time period deemed invalid records; check-out time is set as well; please set according to your own situation.

Shift setting:

Relationship between shift and timetable: 2 steps for shift, firstly need time table, and then set shift, can choose multi-timetable, but less than 4.

The screenshot shows a software window with three tabs: 'TimeTable Setting', 'Shift Setting', and 'Employee Scheduling'. The 'Shift Setting' tab is active. On the left, there is a 'Shift List' section with a 'Shift Name' input field. The main area is titled 'Shift Information' and contains:

- 'Shift Name' input field
- 'Cycles' dropdown menu set to '1'
- 'Cycle Unit' dropdown menu
- 'Add Timetable', 'Del Timetable', and 'Clear Timetable' buttons
- A table with columns: 'Date', 'Timetable 1', 'Timetable 2', 'TimeTable 3', and 'TimeTable 4'. The 'Timetable 1' column is highlighted in blue.

Shift name: input name, e.g.: normal shift

Circle: Setup range: 1-100, default value: 1

Circle unit: day, week, month

Add timetable: Hit add timetable: choose timetable name and date to confirm.

Go back to [Shift setting]. Hit **【Add】** to add

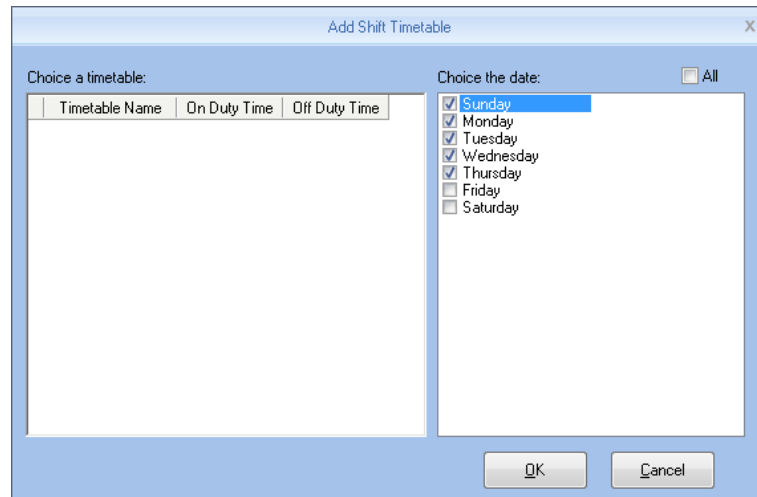

Delete timetable: Choose the timetable, hit **【Del timetable】** to delete.

Clear timetable: Clear all timetable in this shift.

Modify shift:

Choose the shift, and input new name, press **【Modify】** to change

Delete shift:

Choose the shift, hit **【DEL】** and confirm to delete

As Default Class:

Choose this item and the shift will add to new staff automatically.

Employee Scheduling:

Arrange the shift to according staff, support one or multi staff, and also support to temporally staff

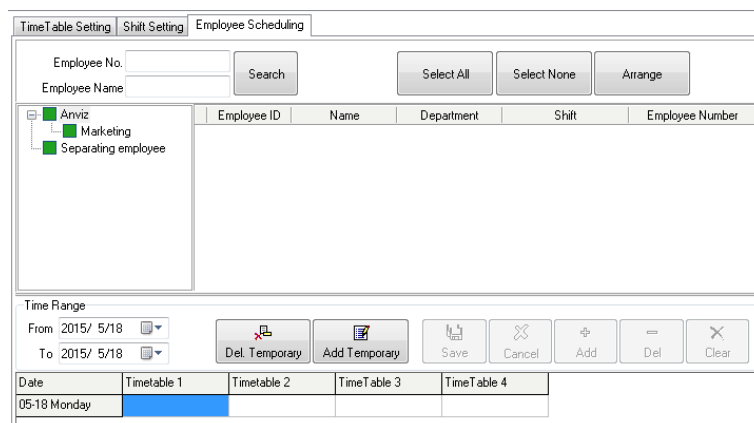

Through 'Employee No.' and 'Employee name' could find the staff and also could find by the list

of department at the left side, all the info will show at right blank of this list.

Notice: Left staff could not be chosen.

Use mouse or shift or ctrl key to choose multi staff, hit **【select all】** or **【select none】** to fix the staff. Hit **【Arrange】** to start arrange shift and go time range.

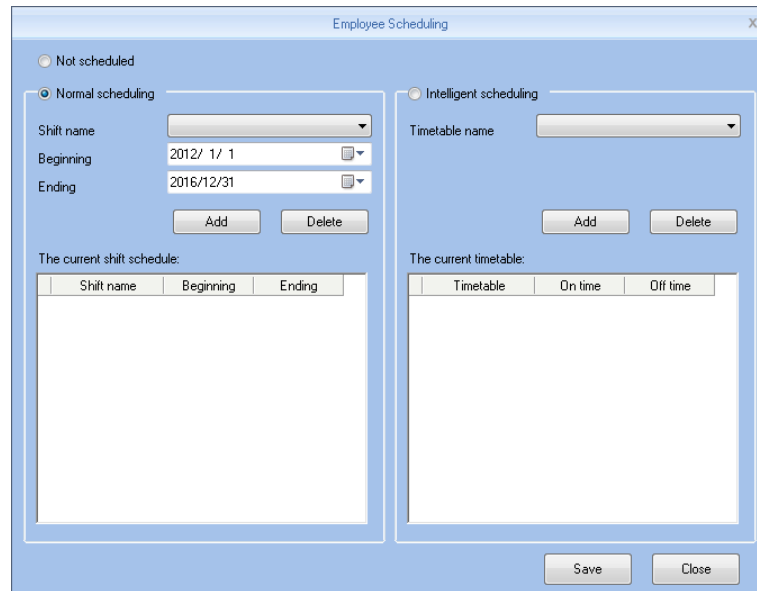

Not Scheduled: Suit the company with random attendance.

If choose this, there will be not late and early status, attendance time will be the first record out deduct first record in, and constantly. If choose this, just press, **【save】** to finish arrange.

Normal Scheduling: Suit the company with confirmed work time.

Choose 'Normal Scheduling' and choose 'shift list' at list, then choose 'beginning' and 'ending', hit **【add】** and will list at 'the current shift schedule', then hit **【save】** to finish.

Then the staff must follow this timetable and shift, the report will also follow this record.

Intelligent scheduling : when the staff need different timetable in one time period, then use this intelligent scheduling function to make the setup simple

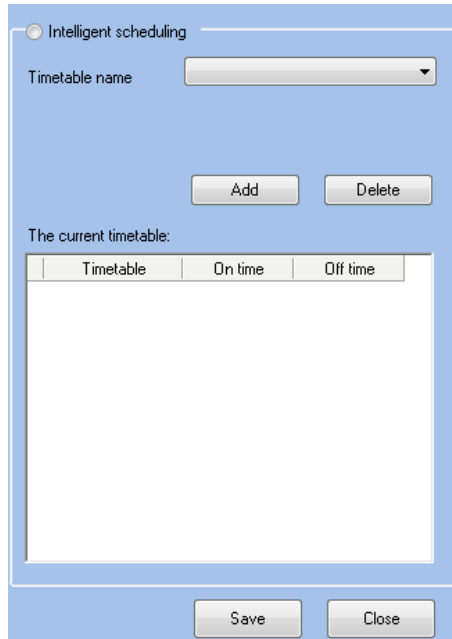

Choose timetables from 'timetable name', hit **【add】**, the timetable will show at 'The current timetable' then to realize the current record.

Temporary: when a staff need to add a temporary, then hit "add temporary"

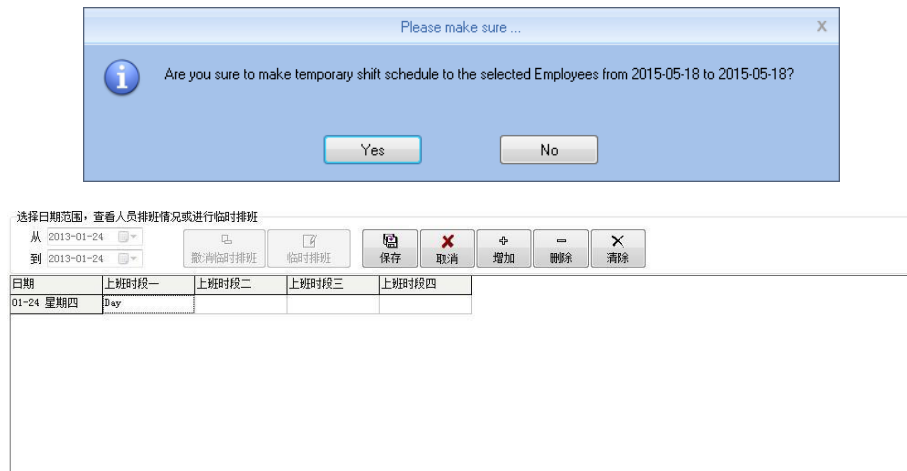

Hit **【yes】**, then hit **【Add】** to open [Add a temporary timetable

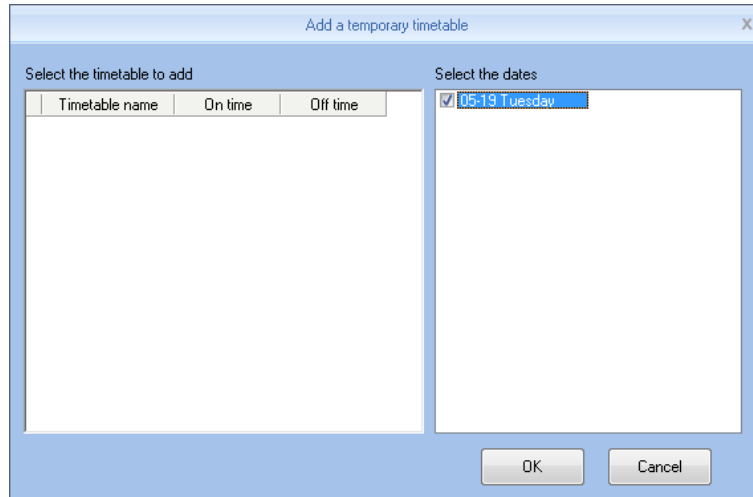

Choose 'Select timetable to add', and confirm 'select the dates' Press **【OK】** and press **【Save】** to finish.

Press **【Cancel】** to delete.

Press **【Clear】** to clear all timetable chosen.

Del Temporary: Delete Temporary list

6.2.10 User setting

Allocate rights for administrator and users

Function module for system authorized management

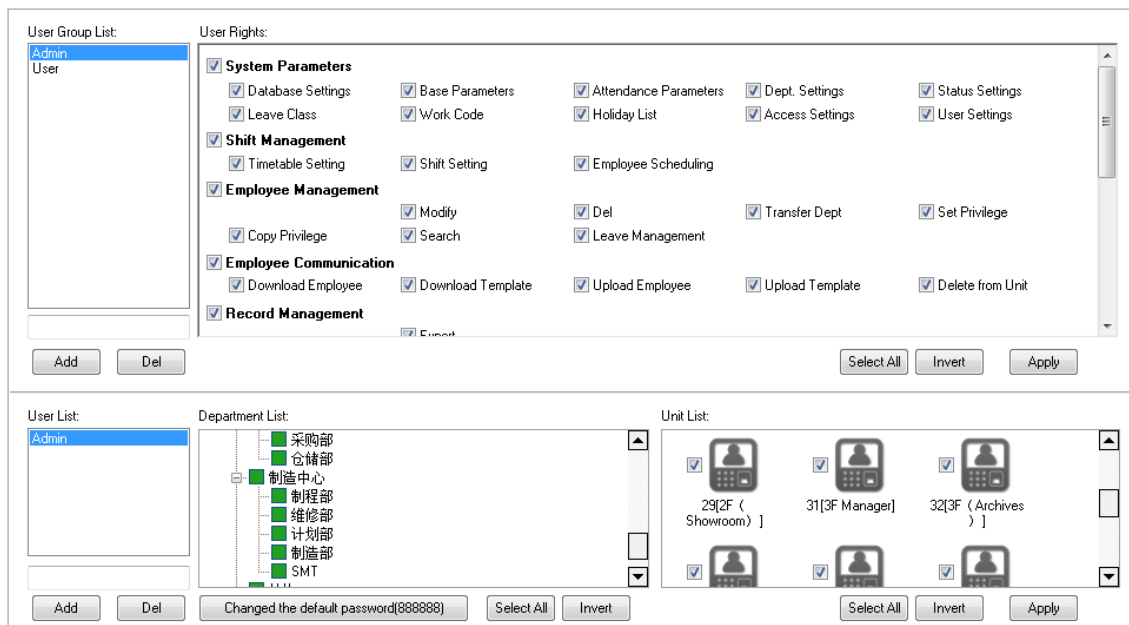

Two parts in User management:

User group list: could device multi groups, realize multilevel management.

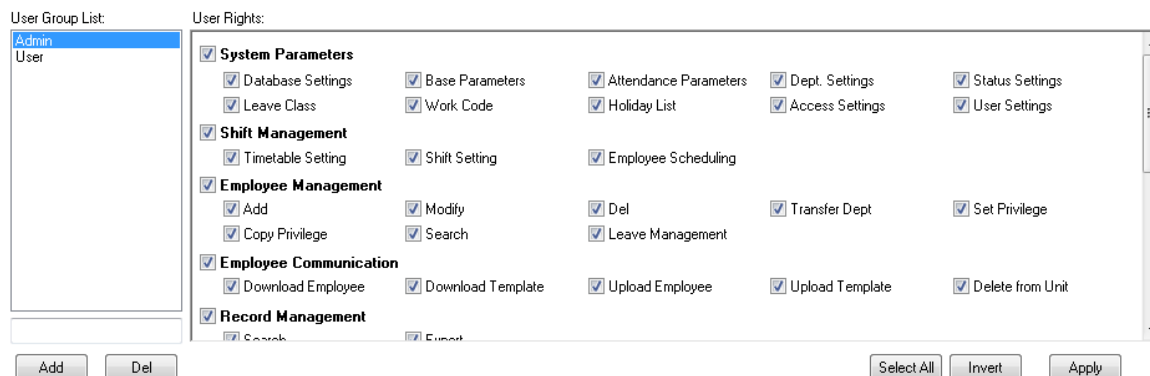

There are two default group in user management, 'Admin' group and 'User' group, Admin has the operation right for the system. And user could be setup by request. Suggest to have one administrator to operate all rights.

Press **【Add】** to input new group(First input name, and hit add), and choose User rights at right side. Press **【Apply】** to add according group. This is easily for clients to realize multi-level management.

User list: We have three list here: 'user list', 'department list' and 'unit list', this means the rights of administrator could diversified into department management and unit management (can only operate the staff in this terminal unit).

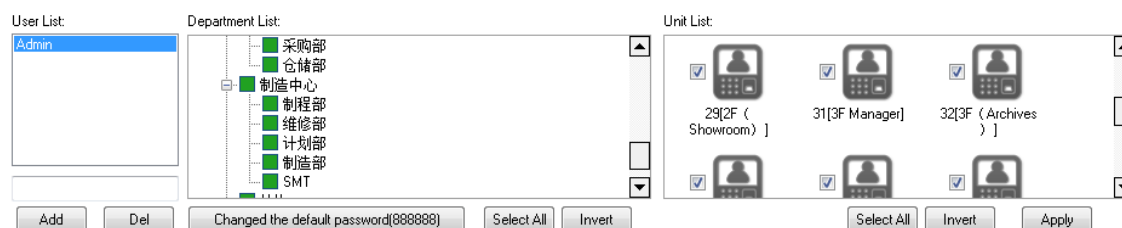

After create User group, choose(admin, user, ……) in the group list, and add at 'user list' to create an account, and choose in 'department list' to choose department and finally choose terminal in 'unit list'

New account default password: 888888

If a password is forgotten, then could let an administrator to hit **【changed the default password(888888)】** to reset the password to: 888888

Press **【Apply】** to realize the updated of the system.

6.2.11 Modify password

Old Password

New Password

Confirm Password

Modify the password, input old password and two times new password, hit “apply”to setup.

Notice: If not input in the new password, then the system would be no password.

6.2.12 Lock Manager

Hit this button, the screen would be locked and need user name and password to restart.

6.2.13 Log out

Hit this button, the screen would be locked and need user name and password to restart.

6.2.14 Exit system

Close the system safely.

6.3 Attendance Management

6.3.1 Statistical Analysis

Click [Statistical Analysis] in [Attendance Management] menu, the following window pops up:

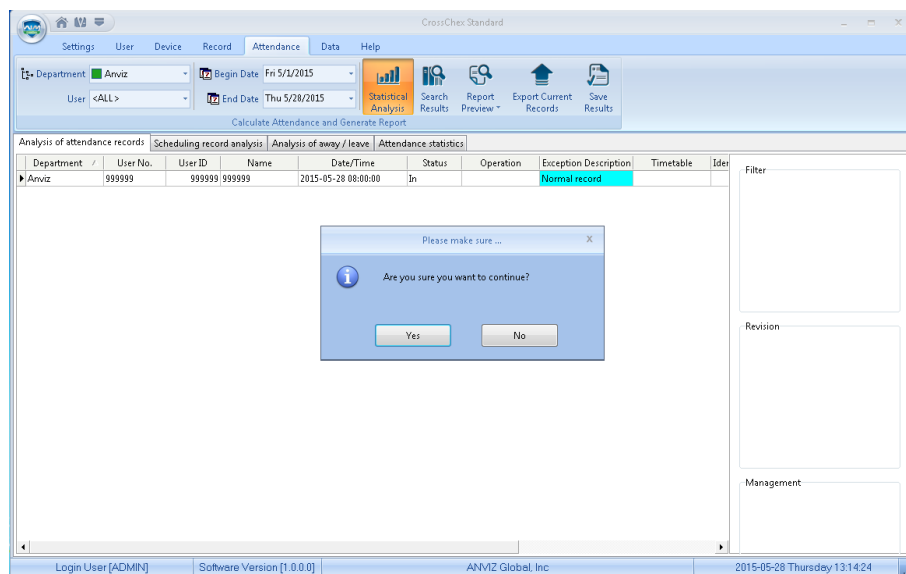

Click **【Yes】** button to continue the operation; Click **【No】** button to discontinue the operation.

6.3.2 Search Results

On the basis of saving the result of Statistical Analysis or the above operation is invalid.

Click [Search Results] in [Attendance Management] menu, the following window pops up:

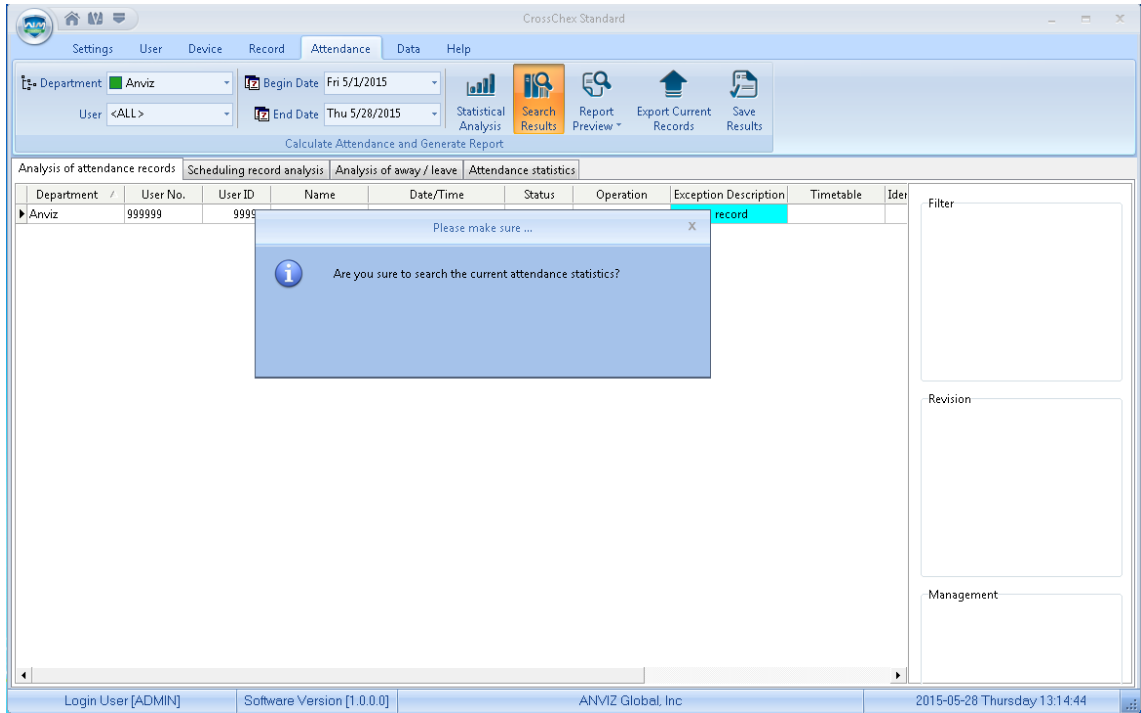

Click **【Yes】** button to continue the operation; Click **【No】** button to discontinue the operation.

6.3.3 Record Management

Click [Record Management], the following window pops up:

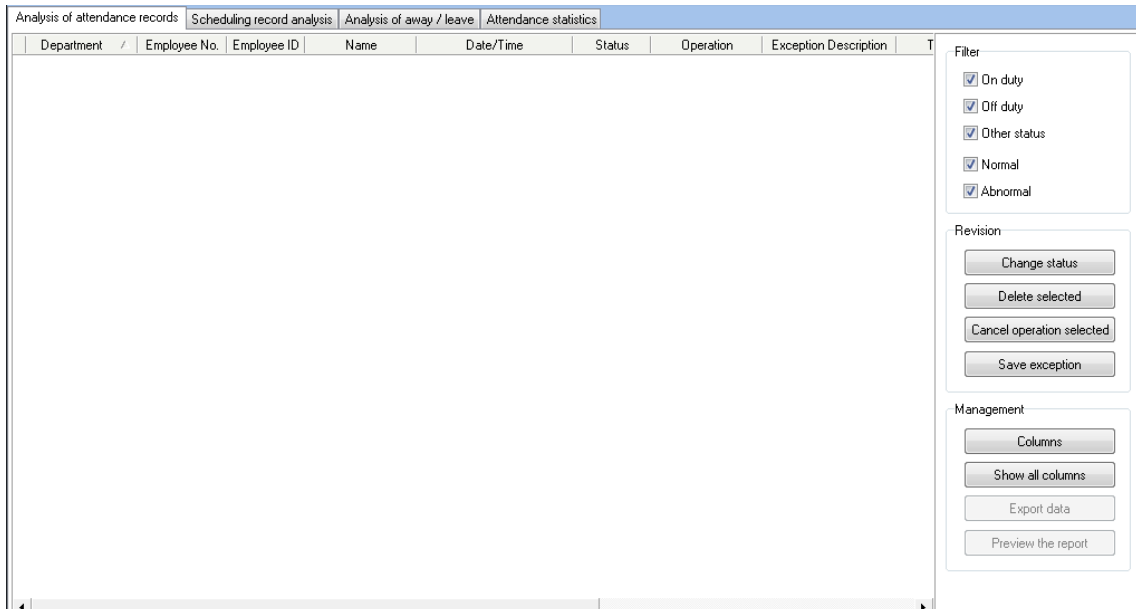

Select the appropriate conditions are shown on the right.

6.3.4 Scheduling Record Analysis

Click [Scheduling Record Analysis], the following window pops up:

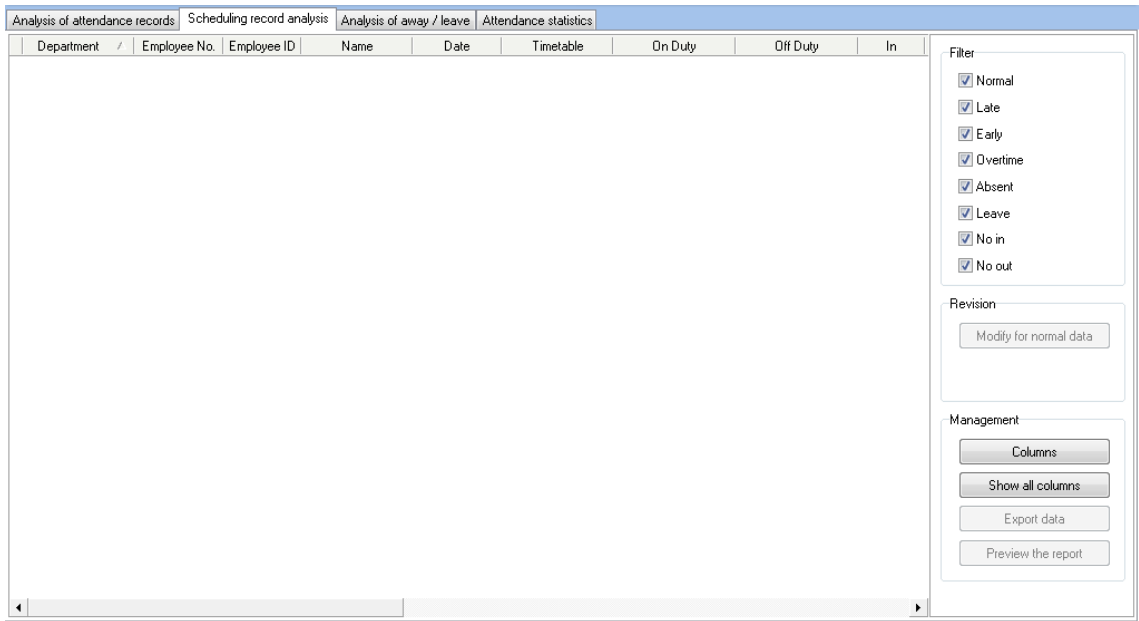

Select the appropriate conditions are shown on the right.

6.3.5 Analysis of Away/Leave

Click [Analysis of Away/Leave], the following window pops up:

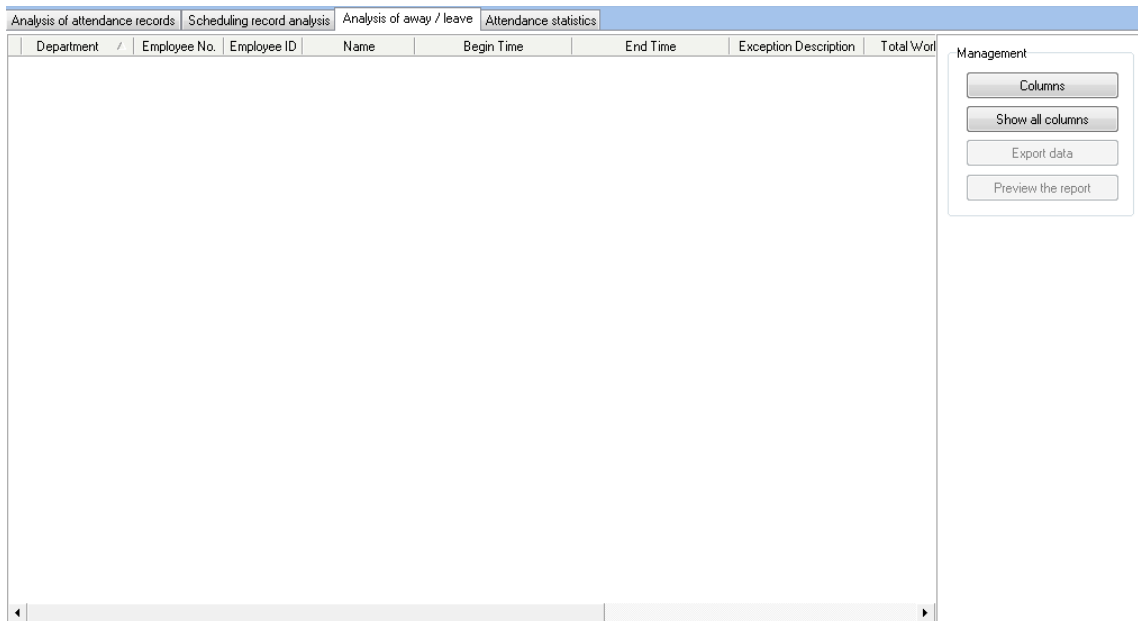

Select the appropriate conditions are shown on the right.

6.3.6 Attendance Statistics

Click [Attendance Statistics] menu, the following window pops up:

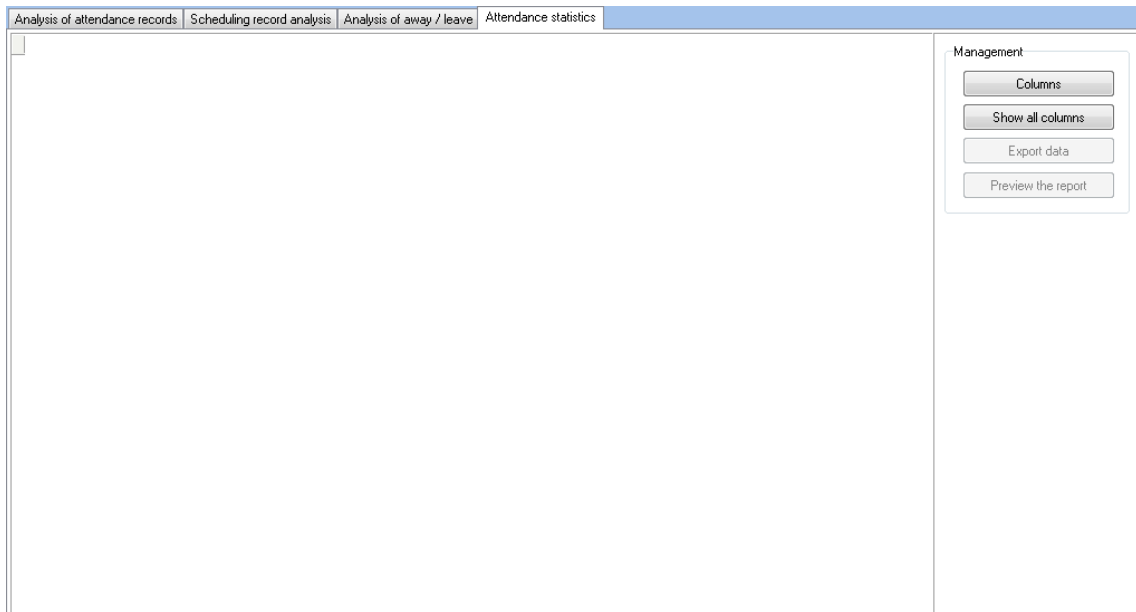

Select the appropriate conditions are shown on the right.

6.3.7 Report Preview

Click [Report Preview] menu, the following window pops up:



Select the report you need accordingly.

6.4 Data Management

6.4.1 Away On Business/Leave

Click [Away On Business/Leave] in [Data] menu, the following window pops up:

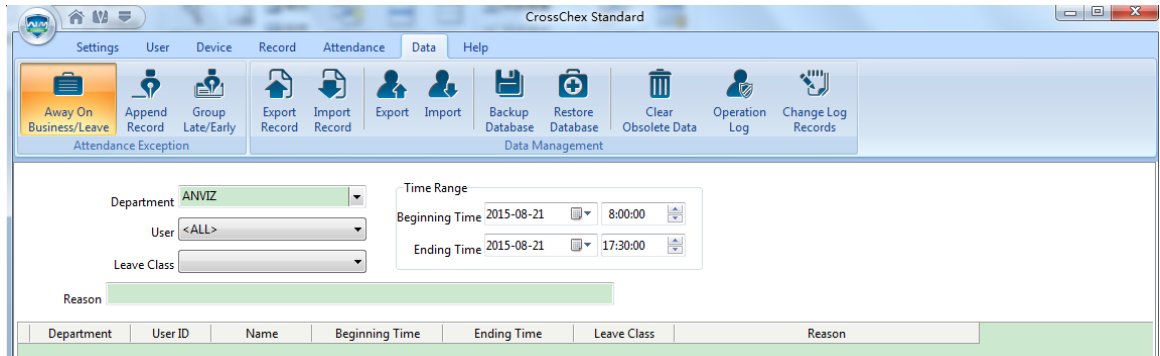

Select Department, Employee, Leave Class, Reason and Time accordingly to complete setting.

6.4.2 Append Record

Click [Append Record] in [Data] menu, the following window pops up:

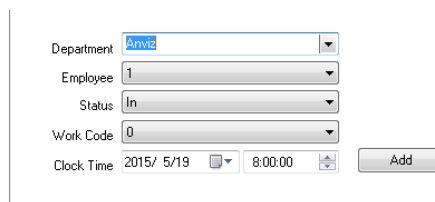

6.4.3 Group Late/Early

Click [Group Late/Early] in [Data] menu, the following window pops up:

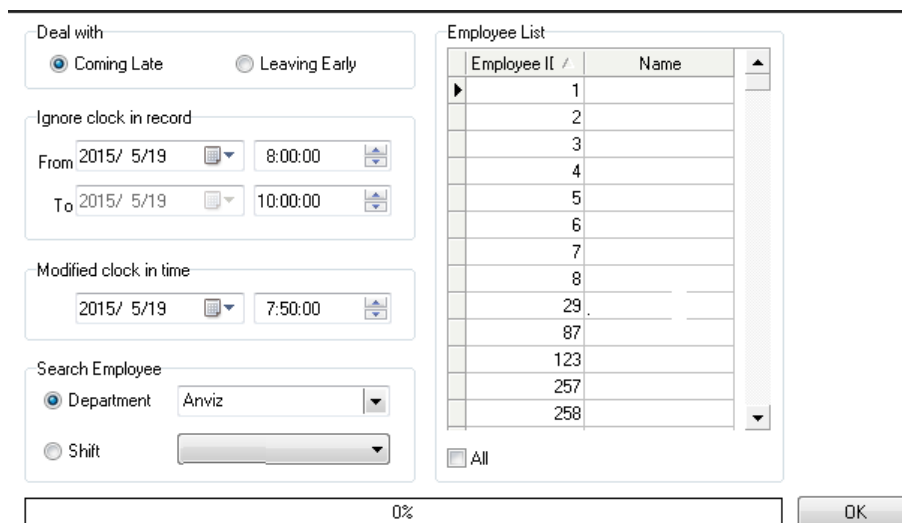

Select the appropriate condition, and click [OK].

6.4.4 Export Record

Click [Export Record] in [Data] menu, the following window pops up:

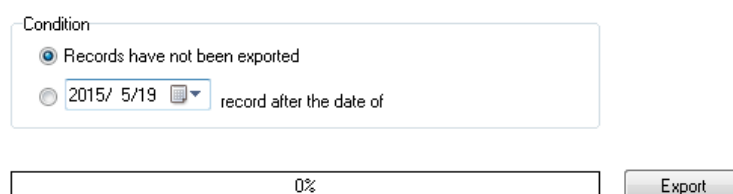

Choose export conditions, click export, select the path, the following window pops up, click 'Save' :

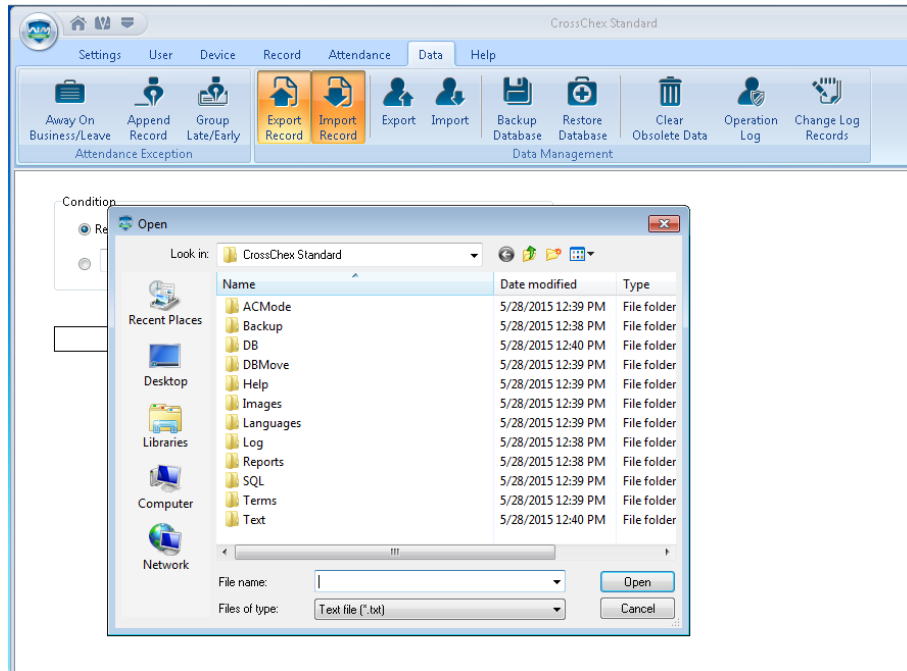

6.4.5 Import Record

Click [Import Record] in [Data Management] menu, the following window pops up:

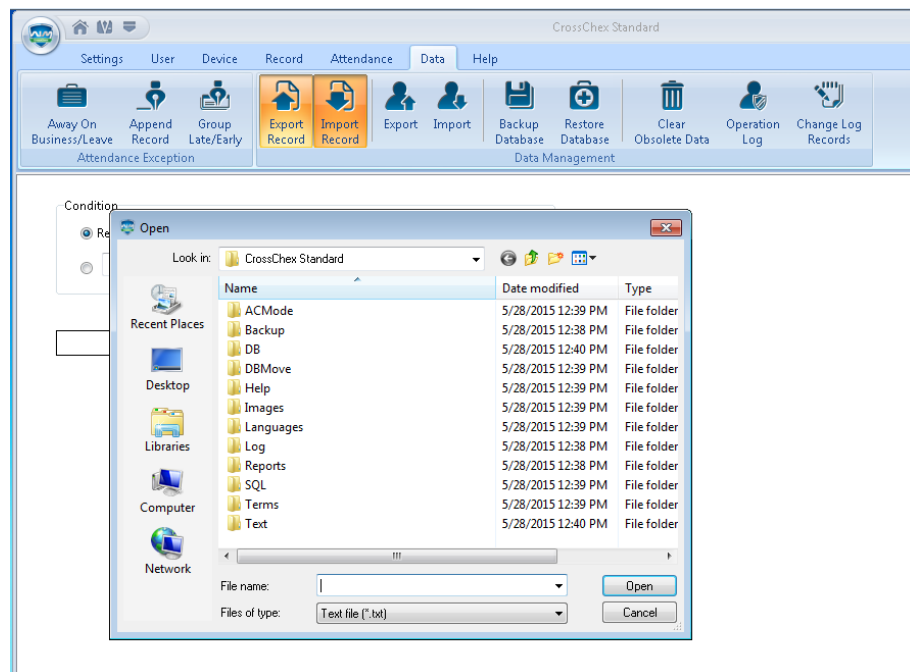

Select the relative import attendance record file according to the prompts, click [Open] button to start importing.

Note: Attendance record file format 'must be original record (*.txt).

Number+ Tab key +Attendance Time (time format yyyy-MM-dd HH:mm:ss)+Tab key+ Device

Number + Tab key+ Attendance Status + Tab key+ Work Code + Tab key+ Verification Mode

6.4.6 Export Employee

Click [Export] in [Data] menu, the following window pops up:

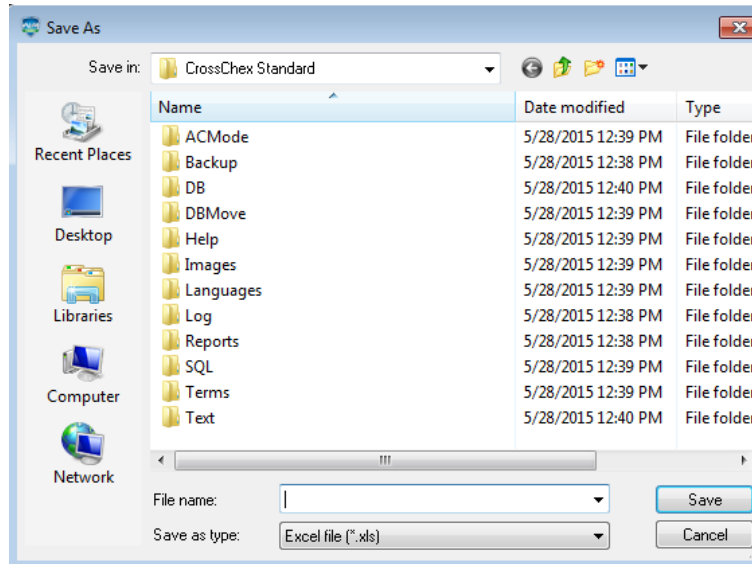

Select “Export EXCEL file” export path.

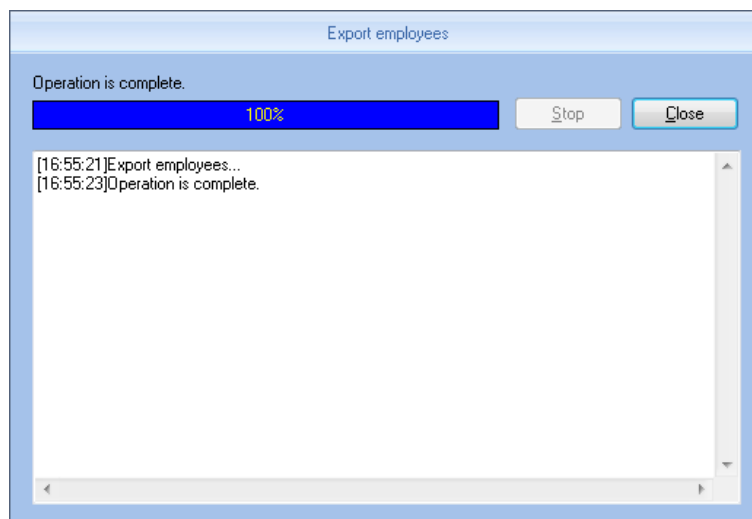

After a successful export, click **【Close】** to complete the export.

6.4.7 Import Employee

To import employee information to the system according to EXCEL prescribed format.

The import employee information EXCEL format is in the software installation directory folder 'ACMode'.

Click [Import] in [Data] menu, the following window pops up:

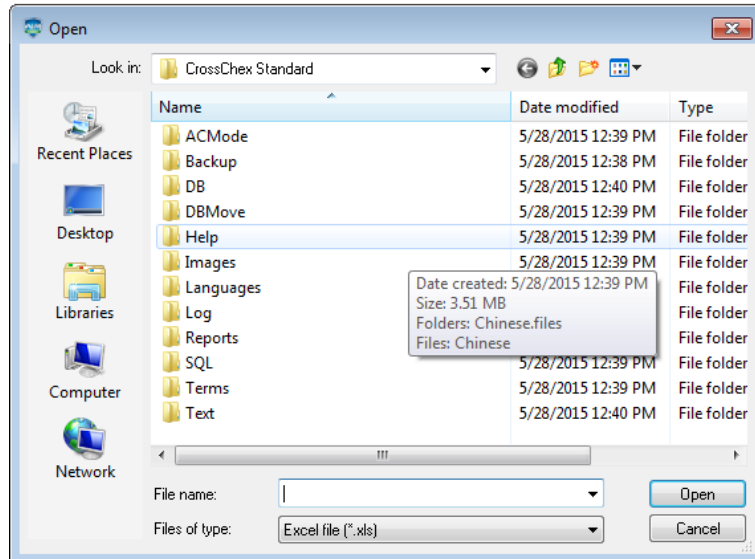

Select the EXCEL file you want to import, click [Open] to popup a dialogue box:

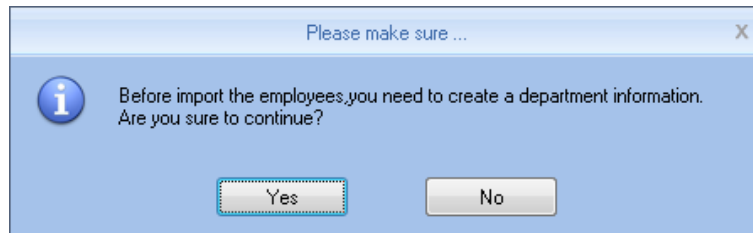

Click **Yes** to confirm, **No** to quite. After a successful import, click **Close** to complete the export.

6.4.8 Backup Database

For ensuring the safety of data and recoverability, we advise to back up the database regularly. Click [Backup Database] in [Data] menu, then select the relative route to back up the database, click [Save]:

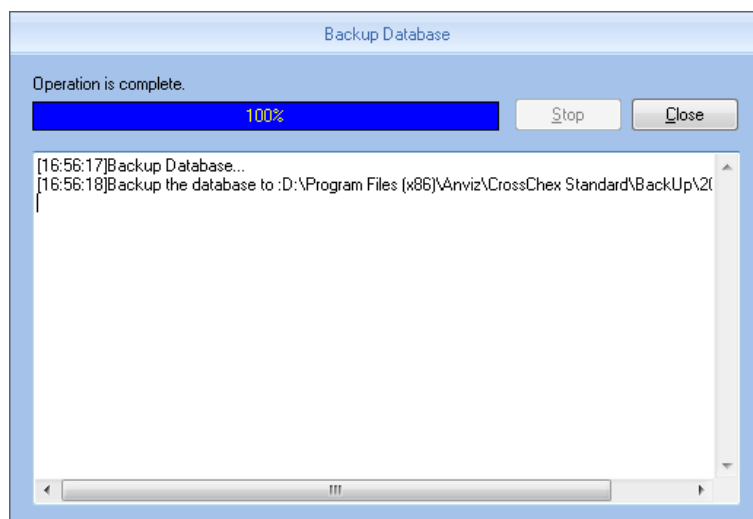

6.4.9 Restore Database

Click [Restore Database] in [Data] menu, the following window pops up:

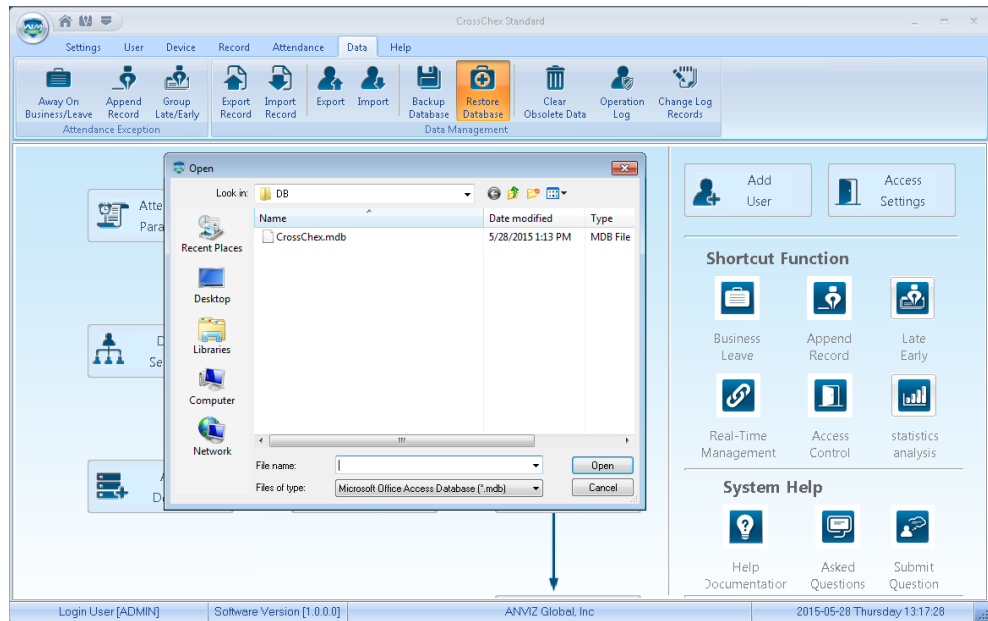

Select the path to the database you want to restore, click [Open], the following window pops up:

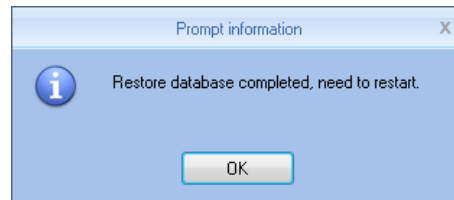

Click **【Confirm】** to restart the software.

6.4.10 Clear Obsolete Date

Click [Clear Obsolete Date] in [Data] menu, the following window pops up:

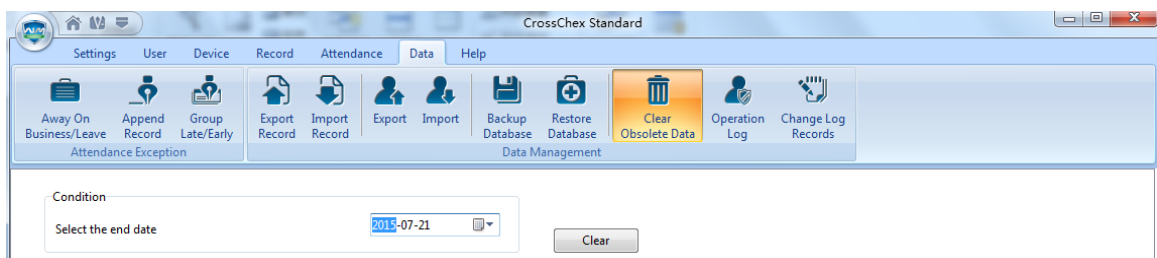

Select the deadline of relative Obsolete Date, click **【Clear】** to complete the operation.

6.4.11 Operation Log

Click [Operation Log] in [Data] menu, the following window pops up:

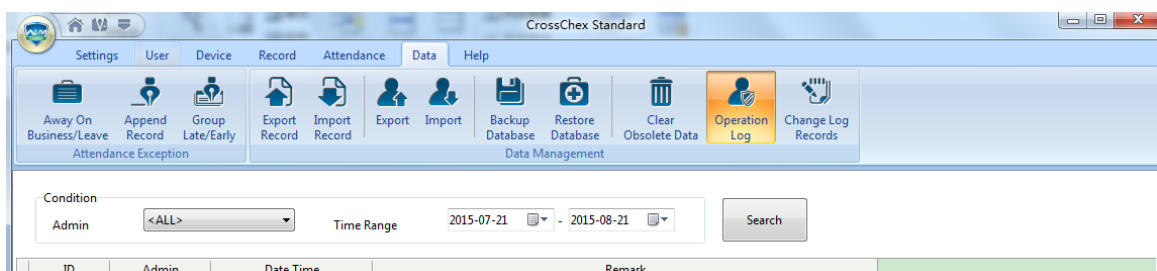

The log records all the Operation Logs in this management program, select [Admin] and the corresponding time period, click [Search] button, then you can see what operations and what settings the administrator has managed in this time period, which is more convenient for multiple administrators using simultaneously.

6.4.12 Change Log Records

Click [Change Log Records] in [Data] menu, the following window pops up:

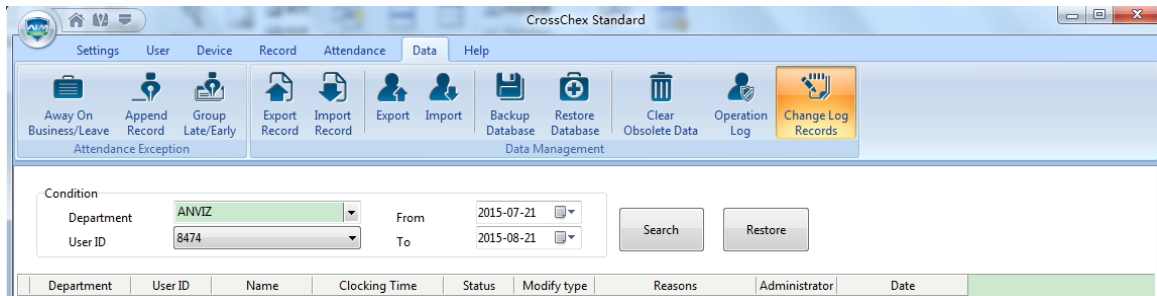

Select Department, Employee ID and Time, click **【Search】** button, then matching records will be displayed in the list below.

Note: Change Log Records show all the modified attendance record; if wrongly modify the record in the process of operating the system, you can select the record, and then click [Restore] button to correct the record.

Click **【Close】** button to exit this window.

6.5 Help

Help including **【Upgrades】**, **【Feedback】**, **【FAQ】**, **【About】**, **【Help】** as below:

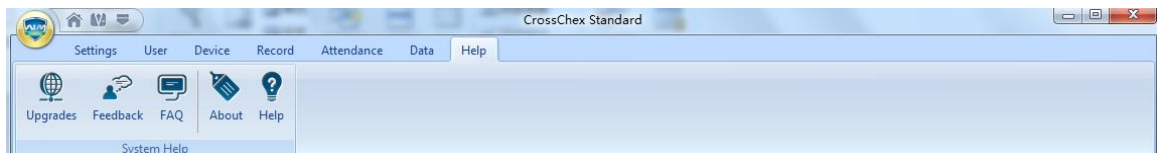

6.6 Software Upgrades

Anviz management software supports online software upgrades. Click **【Upgrades】** button. The system will automatically run, 'Update.exe'. The application will automatically connect to the software server of Anviz Biometric Technology Co., Ltd., find the latest software upgrade in the server, and download the software upgrade package to install, as below:

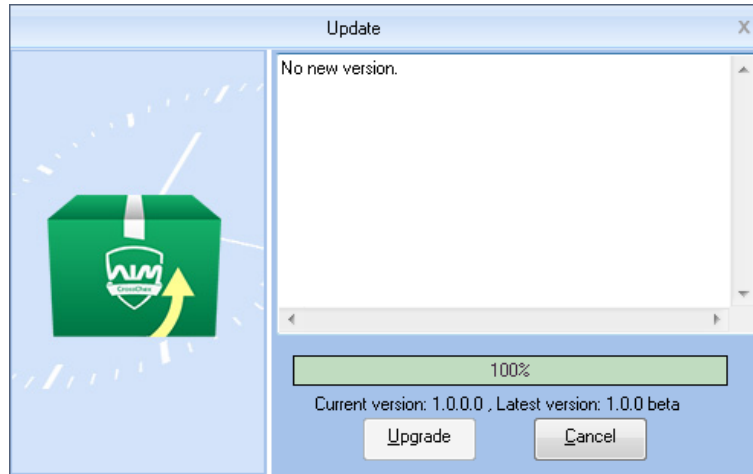

In 'Upgrade' dialog, the version information of the upgrade pack will be prompted. After selecting the latest version, click the **【Upgrade】**, the software upgrade package will be downloaded and installed on your system, and prompts the current software version.

Note: The software upgrade is incremental upgrade, it can effectively reduce the download traffic and data loss, use automatic software upgrade will not overwrite database use, ease of use.

6.7 Feedback

Anviz Technology Co., Ltd always pay attention to the user's software experience, integrating the **【Feedback】** button in the software, enabling customers to submit quickly. Submit the problems and BUG encountered in the process of using software timely, our R&D and technical team will give you the best service.

Click **【Feedback】** requires the customer's computer must be connected to the Internet , and having been registered as a member of Shanghai Anviz Technology Co., Ltd. is required before submit questions.

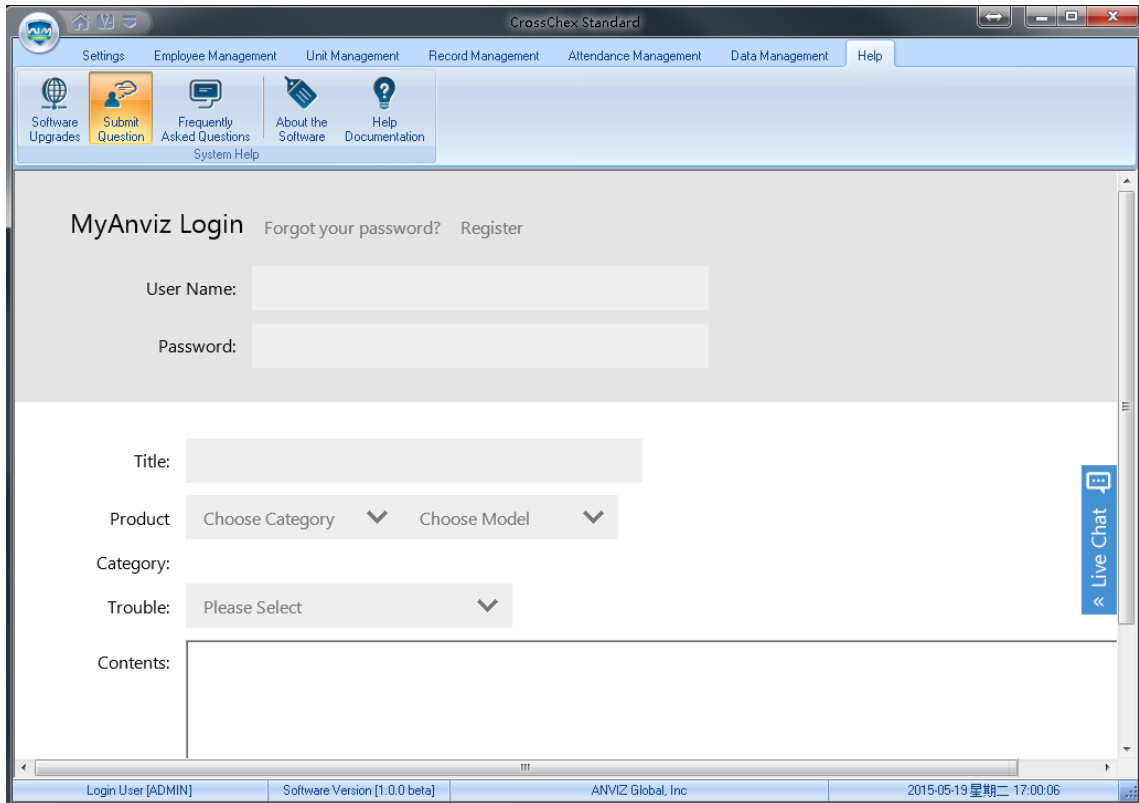

6.8 About the Software

Click **【About】** button, the dialog box of software version information will pops up.



The software version name, company name and the official website, and software copy rights will be displayed.

6.9 Help Documentation

Click the **【Help】** in the software, the system will call System Help Manual; it will be more convenient for the customers to familiar with the software operation and use.

Chapter7 FAQ

Frequently asked questions and answers.



7 FAQ

7.1 My fingerprint has been enrolled but often failed in identification.

Reason	Solution
1. The fingerprint was not captured properly	Enroll the finger again. Please refer to illustration of pressing finger.
2. Direct sun light or too bright light	Avoid direct sun light or other bright light
3. Too dry finger	Touch the forehead to increase oily level of the finger.
4. Too wet finger with oil or cosmetics	Clean fingers with towel
5. Low fingerprint quality with callus or peeling	Enroll other fingers with better quality
6. Wrong way in placing fingers when punching in/out	Please refer to illustration of pressing finger.
7. Latent fingerprint on the surface of sensor	Clean sensor surface
8. Not enough finger pressure	Place the finger evenly on the sensor with moderate pressure
9. Influence by fingerprint image change	Enroll fingerprint again. Please refer to illustration of pressing finger.
10. Fingerprint not enrolled yet	Place enrolled finger.

7.2 T&A system can't be connected with PC

Reason	Solution
1. Communication method not set correctly	Select the correct communication method
2. Cable not plugged firmly or cable hardware problem	Plug the cable firmly or change another cable
3. Not able to connect COM (wrong COM No.)	Please enter the right COM No.
4. Not able to connect Net (wrong setting)	Please refer to TCP/IP Set. Connecting Time Attendance terminal

7.3 No records found even though staff have clocked in/out

Reason	Solution
1. Unit power break for a long time (time turn to zero as default)	Please refer to the manual for time synchronization
2. Minority staff fingerprint false accepted	1. Please refer to the manual. You can add the records manually. 2. Please refer to the manual. You can adjust the fingerprint matching precision. 3. Enroll another fingerprint. And then try again.

7.4 The user cannot identify

Reason	Solution
1. In the sleeping mode	Press any key one the keypad

2. The device is communicating or communication interruption	1.Disconnect the connection 2.Resolve the wire interruption
3. Fingerprint sensor control board abnormal	Restart the machine.

7.5 Staffer can't pass although used the User ID+FP mode

Reason	Solution
1. Enter wrong User ID	Enter the correct User ID
2. This user do not have the 1:1 identification privilege	Set the 1:1 identification privilege

7.6 The unit beeps automatically when no one punches in/out

Reason	Solution
1. Direct sun light or too bright light	Avoid direct sun light or other bright light
2. Latent fingerprint on the surface of sensor	Clean sensor surface

7.7 Software connection failed

Reason	Solution
1. Wrong connection mode	Select correct connection mode (LAN or USB)
2. Wrong device ID	Input correct device ID
3. Malfunction network cable	Check PING command and change a good cable
4. Network Settings incorrectly	Both PC and device should be in the same network
5. IP addresses conflict	Reconfigure IP address

Notice: If you have any other problems, please kindly email us the log files in '.zip' or '.rar' (The log files are in the folder "Log" in the installation directory of the software)

In order to better help customers to solve the software and equipment problems encountered in the process, we integrate **【Frequently Asked Questions】** button in the software. Click the button when your computer is with installed system connecting to the Internet. Software also will automatically connect to the technical support page on Shanghai Anviz Technology Co.,Ltd. official website.

Users can quickly find the software and equipment problems encountered by "Frequently Asked Questions Database". Customers can follow the detailed help files to solve their own problems encountered efficiently.

Chapter 8 Appendix

The main theme of this chapter is the additional information of this T&A including access control and cable connection.

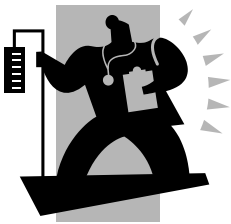

8 Appendix

8.1 Communication And Power Interface

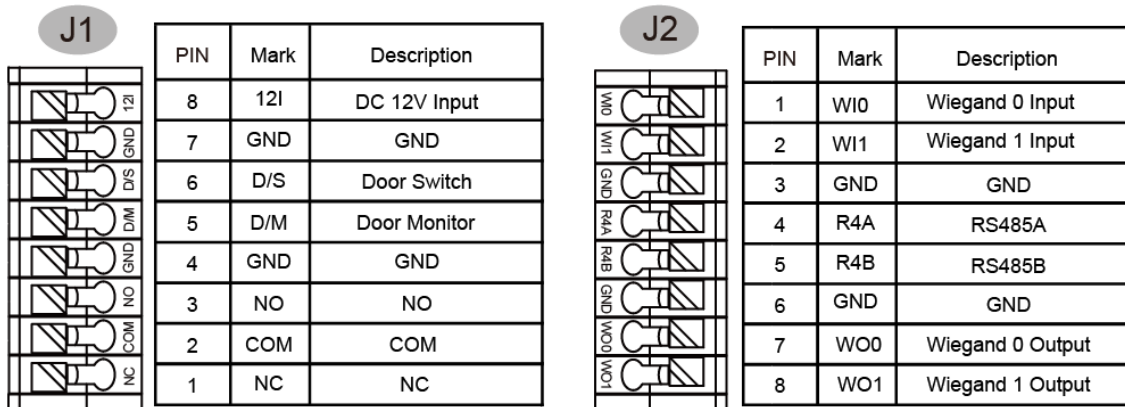

8.2 Access Wiring Diagram

1. POE Supply connecting E-Lock

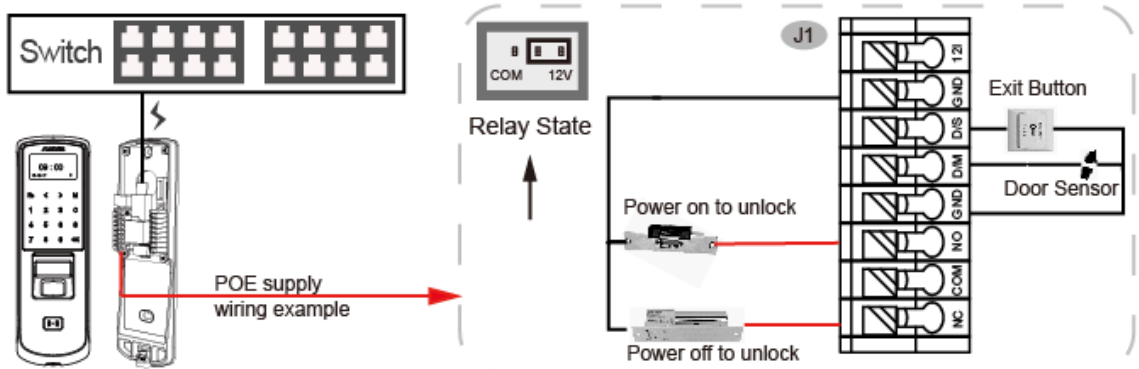

2. Connecting E-Lock with Access Control Power

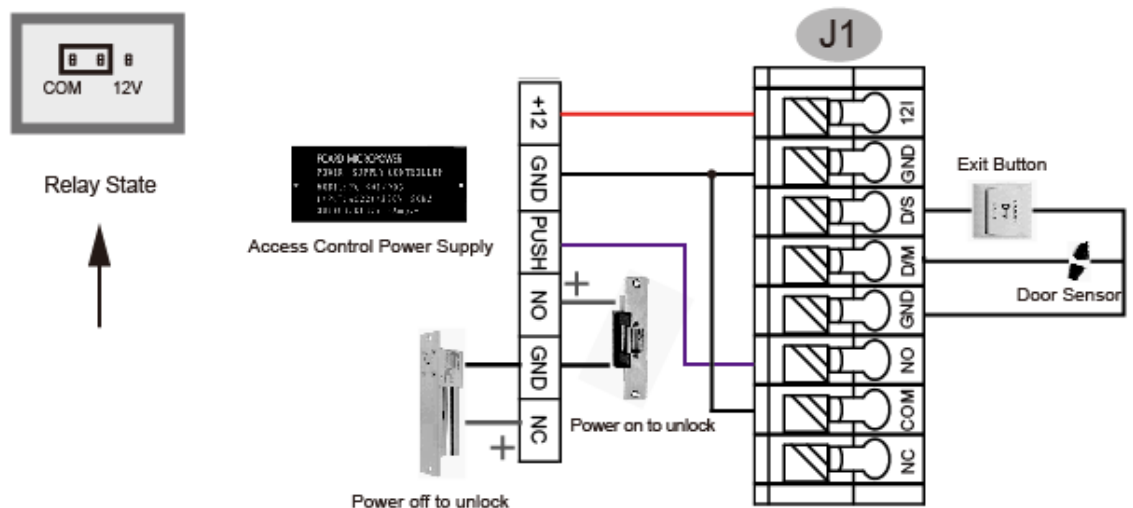

3. Connecting E-Lock with Switching Power

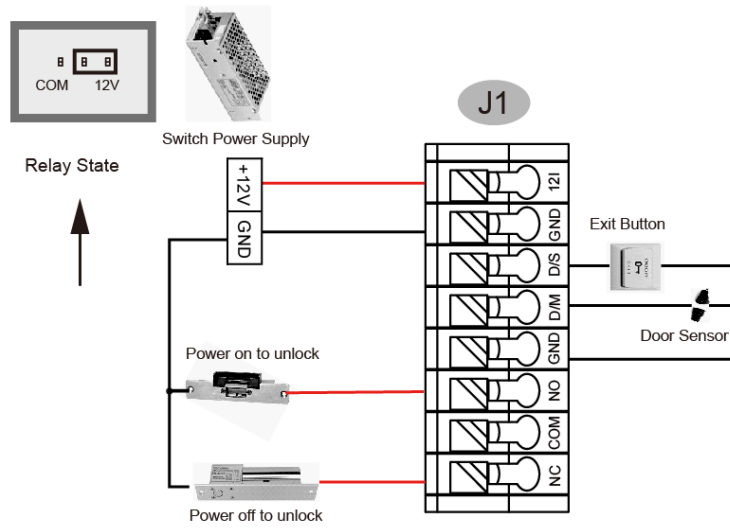

Use the following wiring is recommended to prevent damage to the access control when load is large.

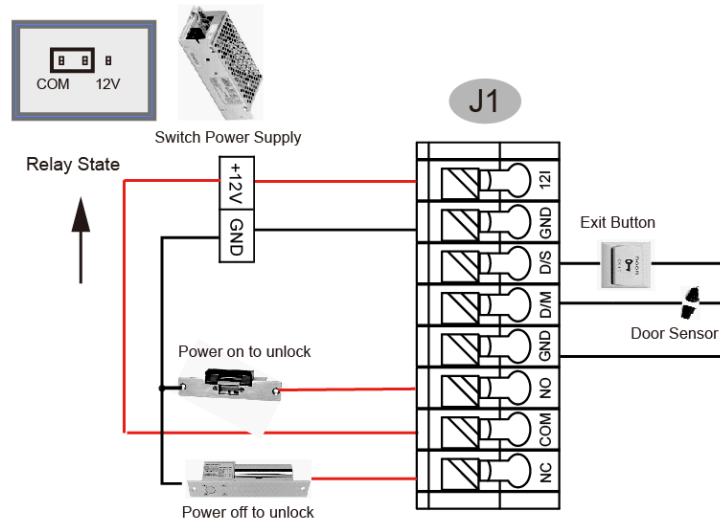

4. Connecting Wiegand Output to External Controller

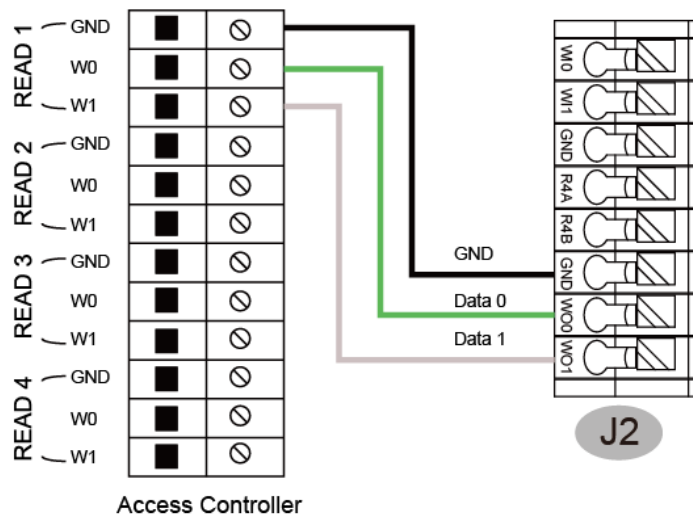

5. Wiegand Card Reader Connection

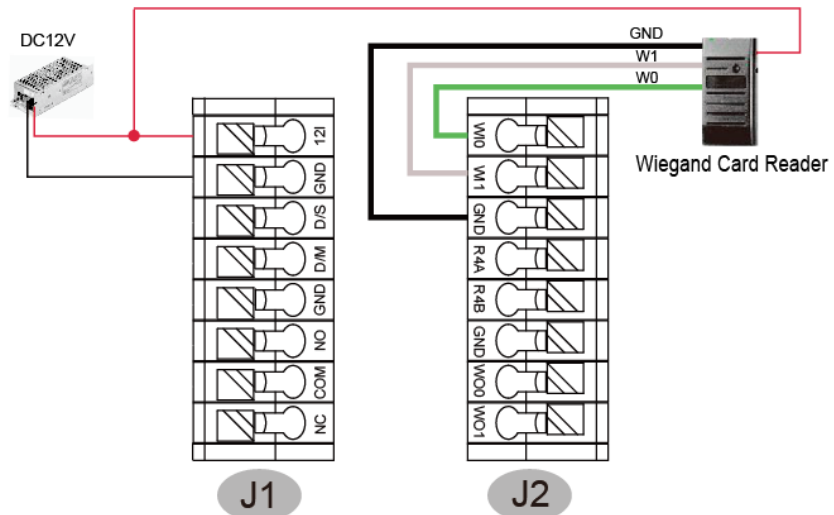

6. Connect P7 With SC011 of Anviz

